



# SUPERBOLT TECHNOLOGY

Advanced bolting solutions

 **SUPERBOLT™**  
PART OF THE NORD-LOCK GROUP





---

# WHATEVER COMES ALONG, WE HOLD IT TOGETHER.

---

Superbolt was the world's first to revolutionize nuts and bolts with the multi-jackbolt tensioner (MJT) in 1984. Since then, Superbolt has proven its technology in tens of thousands of successful installations. Superbolt tensioners are easy to work with and provide an overwhelming mechanical advantage with their unique design, which divides the load among multiple small jackbolts. Once installed properly, MJT connections are reliable, and can stay tight indefinitely. Even MJTs of enormous sizes are safe and can be installed or removed by a single worker with ordinary hand tools.

But the revolution hasn't stopped here. Superbolt continues to develop a multitude of solutions to solve the next generation of bolting challenges. With the widest range of tensioners on the market and constant growing portfolio, Superbolt has got you covered.

Superbolt is a part of the Nord-Lock Group. Our global team of sales engineers and partners will give you the support needed to ensure that your bolted connections are optimized and safe.





<b>THE SUPERBOLT STORY</b>	<b>6-15</b>
Product portfolio About us Our technology Benefits & common applications Lifetime Warranty	
<b>NEWS &amp; INNOVATIONS</b>	<b>16-25</b>
VersaTite GT/GTS EzFit HyFit	
<b>STANDARD NUT &amp; BOLT-STYLE TENSIONERS</b>	<b>26-35</b>
GT, GTS, MT, CY, SB8, SB12, H650, H650T	
<b>REACTIVE SIDE SOLUTIONS</b>	<b>36-39</b>
Flexnuts SX8, SX12	
<b>COMPACT/LOW-PROFILE TENSIONERS</b>	<b>40-47</b>
SJ, SJX2, SSJX2, NM2/NI2, SMX2	
<b>DYNAMIC APPLICATION TENSIONERS</b>	<b>48-53</b>
CN, SP, MR, MRA	
<b>CUTTING-EDGE SOLUTIONS</b>	<b>54-61</b>
<p><b>EXTREME REQUIREMENTS</b></p> <ul style="list-style-type: none"> <li>• Large diameters &amp; high preload, STC</li> <li>• High &amp; low temperature</li> <li>• Environmental &amp; corrosion protection</li> </ul> <p><b>EXTREME INDUSTRY APPLICATIONS</b></p> <ul style="list-style-type: none"> <li>• Including space, nuclear, fusion, defense</li> </ul> <p><b>UNIQUE DESIGNS FOR YOUR REQUIREMENTS</b></p> <ul style="list-style-type: none"> <li>• Offshore/Sub-sea</li> <li>• Externally threaded tensioners</li> <li>• Tamper-proof tensioners</li> <li>• Customized studs</li> </ul>	
<b>NORD-LOCK GROUP</b>	<b>62-63</b>



## STANDARD NUT & BOLT-STYLE TENSIONERS

New Global Tensioner for a wide variety of general industry applications. Suitable for common grade studs/bolts.

New Super High-Strength Global Tensioner for extreme-strength bolts.

For general mechanical applications; suited for medium-strength bolts and studs; fit in the same space as heavy hex nuts; feature hex-head jackbolts.

For higher bolt loads on general machinery applications; fit in the same space as heavy hex. Use with high-strength bolts and studs.

	GT	GTS	MT	CY
Range Metric	M16-M160	M16-M100	M16-M160	M16-M160
Range Imperial	3/4"-6"	3/4"-4"	3/4"-6"	3/4"-6"
Approx. bolt stress depending on size	400 to 1000 N/mm <sup>2</sup> 60 to 145 ksi	400 to 1200 N/mm <sup>2</sup> 60 to 175 ksi	400 to 750 N/mm <sup>2</sup> 60 to 100 ksi	400 to 1000 N/mm <sup>2</sup> 60 to 145 ksi
Temperature range C	-40 to 250 °C	-40 to 250 °C	-40 to 250 °C	-40 to 250 °C
Temperature range F	-50 to 500 °F Lower temperatures on demand	-50 to 500 °F Lower temperatures on demand	0 to 500 °F	-50 to 500 °F Lower temperatures on demand
Jackbolt lubricant	P37 Sizes > M100/4" become GTX and use LB 8012	P37	P37	P37

## COMPACT/LOW-PROFILE TENSIONERS

For applications involving limited headroom or thread engagement.

Similar to SJ but for higher preloads; moly-lubricated set screws.

To match countersink dimensions of standard sockethead cap screws.

Interchangeable with many standard series locknuts; ideal for positioning bearings or clamping entire shaft assemblies.

Replace standard OEM mill motor armature nuts; available for most standard motor frame sizes.

	SJ	SJX2	SSJX2	NM2/NI2	SMX2
Range Metric	M20-M160	M20-M160	M20-M100	M30-M160	M30-M160
Range Imperial	3/4"-6"	3/4"-6"	3/4"-4"	1"-6-1/4"	1"-4"
Approx. bolt stress depending on size	100 to 450 N/mm <sup>2</sup> 15 to 65 ksi	300 to 650 N/mm <sup>2</sup> 45 to 95 ksi	350 to 800 N/mm <sup>2</sup> 50 to 115 ksi	20 to 90 N/mm <sup>2</sup> 3 to 15 ksi	100 to 250 N/mm <sup>2</sup> 15 to 35 ksi
Temperature range C	-10 to 250 °C	-10 to 250 °C	-10 to 250 °C	-10 to 250 °C	-10 to 250 °C
Temperature range F	0 to 500 °F	0 to 500 °F	0 to 500 °F	0 to 500 °F	0 to 500 °F
Jackbolt lubricant	P37	LB 8012	LB 8012	LB 8012	LB 8012

## DYNAMIC APPLICATION TENSIONERS

For recip. compressor crossheads; special installation procedure simplifies bolting.

Specially designed to match counterbore dimensions of piston-end nuts they replace.

For rotating equipment; with captive jackbolts.

Captive countersunk jackbolts "armored" for harsh environments, also good for coupling bolting.

	CN	SP	MR	MRA
Range Metric	M36-M160	M36-M160	M16-M125	M20-M125
Range Imperial	1-1/2"-6"	1-1/2"-6"	3/4"-5"	3/4"-5"
Approx. bolt stress depending on size	210 N/mm <sup>2</sup> 30 ksi	210 N/mm <sup>2</sup> 30 ksi	300 to 550 N/mm <sup>2</sup> 45 to 80 ksi	350 to 650 N/mm <sup>2</sup> 50 to 95 ksi
Temperature range C	-10 to 250 °C	-10 to 250 °C	-10 to 250 °C	-10 to 250 °C
Temperature range F	0 to 500 °F	0 to 500 °F	0 to 500 °F	0 to 500 °F
Jackbolt lubricant	P37	P37	P37	P37



## STANDARD NUT & BOLT-STYLE TENSIONERS

Bolt-style tensioners for applications with tapped holes; fit in tight spaces; external hex for installation and removal.

Similar to SB8 bolt-style tensioners; for high-strength.

Replace standard hex nuts at temperatures up to 350°C (650°F).

Replace most castle nuts at 350°C (650°F) for tight spaces.

	SB8	SB12	H650	H650T
Range Metric	M16-M160	M20-M90	M20-M125	M24-M100
Range Imperial	3/4"-6"	3/4"-3-1/2"	3/4"-5"	1"-4"
Approx. bolt stress depending on size	350 to 650 N/mm <sup>2</sup> 50 to 95 ksi	550 to 850 N/mm <sup>2</sup> 80 to 125 ksi	310 N/mm <sup>2</sup> 45 ksi Based on stress area AS	310 N/mm <sup>2</sup> 45 ksi Based on stress area AS
Temperature range C	-10 to 250 °C	-10 to 250 °C	-10 to 350 °C	-10 to 350 °C
range F	0 to 500 °F	0 to 500 °F Lower temperatures on demand	-50 to 650 °F	-50 to 650 °F
Jackbolt lubricant	P37	P37	P37	P37

## FLEXNUTS

Reactive nut for through-hole applications. Adds elasticity to bolted joints. Use in combination with MT or SB8.

Similar to SX8 but use in combination with CY or SB12.

	SX8	SX12
Range Metric	M20-M160	M20-M160
Range Imperial	3/4"-6"	3/4"-6"
Approx. bolt stress depending on size	400 to 750 N/mm <sup>2</sup> 60 to 100 ksi	400 to 1000 N/mm <sup>2</sup> 60 to 145 ksi
Temperature range C	-10 to 250 °C	-40 to 250 °C
range F	0 to 500 °F	-50 to 500 °F Lower temperatures on demand

# SUPERBOLT AT A GLANCE

Superbolt offers a full range of standard, pre-engineered, and specialty solutions. This chart provides a quick overview of our core products. For additional selection help, our application engineers will work with you to find the optimal solution.

## CUTTING-EDGE SOLUTIONS

### EXTREME REQUIREMENTS

Large diameters & high preload, STC  
High & low temperature  
Environmental & corrosion protection

### EXTREME INDUSTRY APPLICATIONS

Space, Nuclear, Fusion, Defense

### UNIQUE DESIGNS FOR YOUR REQUIREMENTS

Externally threaded tensioners  
Tamper proof tensioners  
Customized studs





# THE MAN FROM PITTSBURGH WHO CHANGED BOLTING TECHNOLOGY FOREVER

World-renowned Superbolt, Inc., got its start in Pittsburgh, Pa., USA, when the region was best known as America's "Steel City". In 1974, local inventor Rolf Steinbock was designing and building custom equipment for the steel industry. A local steel manufacturer purchased one of his designs, a scrap chopper, which solved problems that plagued older devices. But the new machine's constant rotation tended to loosen critical bolts. Downtime for maintenance became a daily necessity, and it involved re-tightening with a heavy wrench and a sledge hammer.

Mr. Steinbock took one look at this hazardous, repetitive chore and came up with a better idea: Instead of struggling with the massive torque of large hex nuts, why not divide the torque into multiple manageable forces?

He sketched out the first multi-jackbolt tensioner (MJT) for fabrication by a local machine shop. With a set of MJTs installed, the scrap chopper's bolts never came loose again. Mr. Steinbock patented his invention and founded Superbolt, Inc., in 1984 and in 1988 a sister company in Switzerland was founded. After almost three decades of growth, both companies became part of the Nord-Lock Group, the global leader in secure bolting solutions, in 2011.

Ever since the introduction of the MJT, solving tough bolting challenges has been our quest. Today you can choose from an extensive range of standard and pre-engineered designs, within our portfolio or as a customized design, all based on decades of experience in tensioner technology.

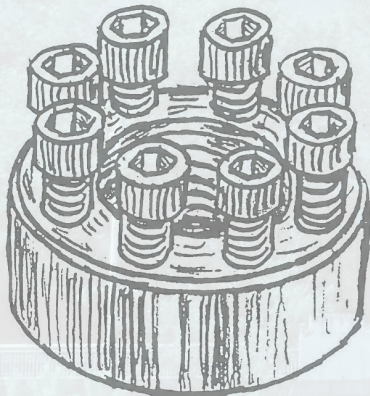

*Early sketch of a Superbolt used in the very first advertisement.*

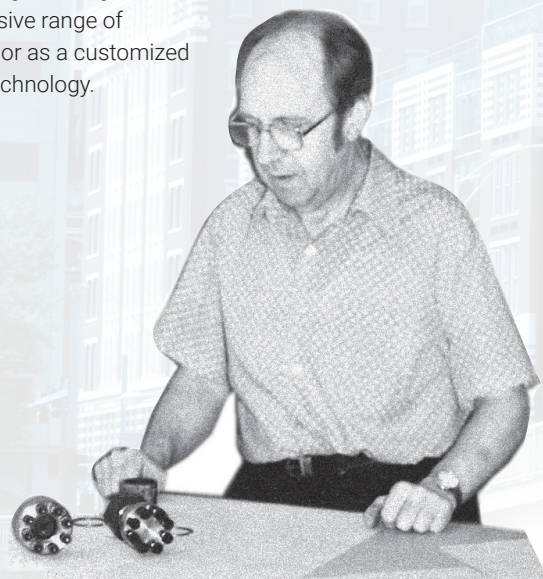

*Rolf Steinbock testing early Superbolt designs.*



**IF YOU'RE NOT USING SUPERBOLT TENSIONERS, YOU'RE WORKING TOO HARD.**

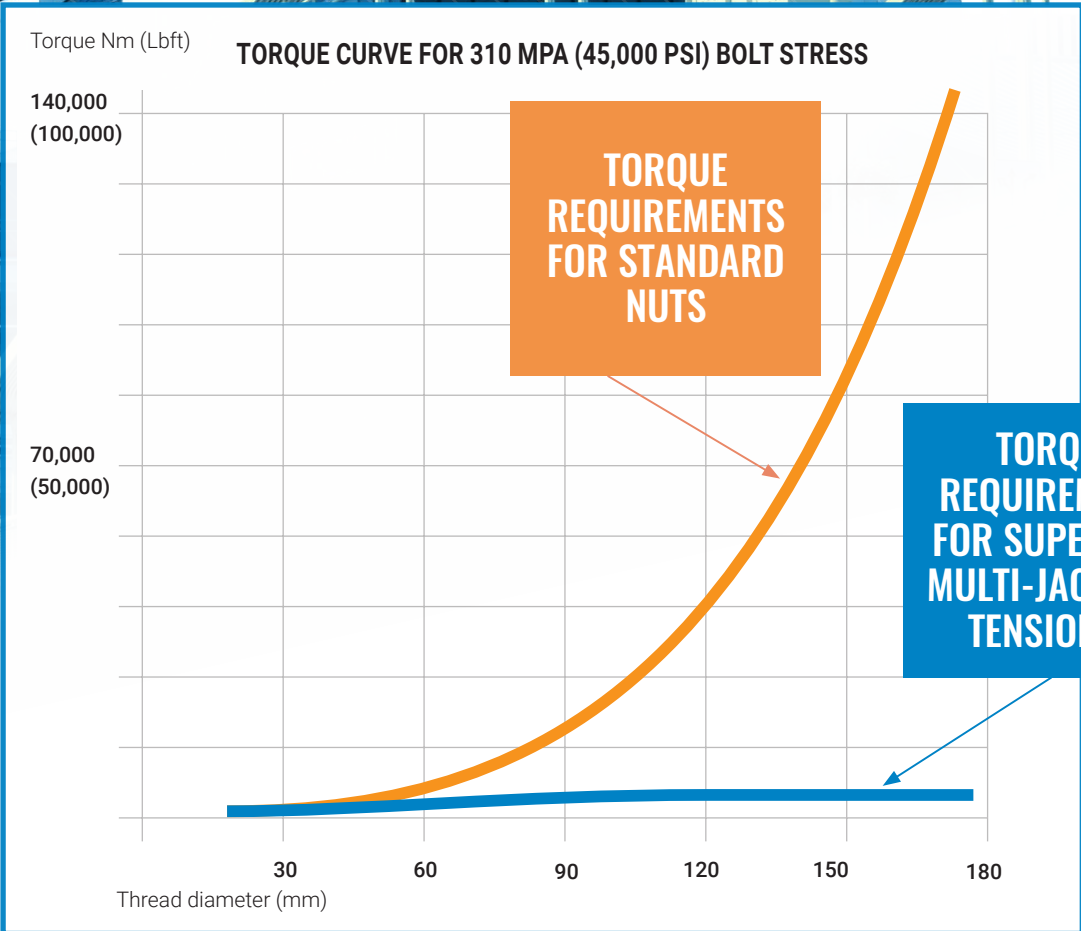

The chart shows how Superbolt tensioners remain easy to install, even on larger sizes, compared to standard hex nuts. Only hand tools are required to tighten any diameter stud/bolt.



## The Superbolt Principle

Superbolt tensioners are designed as direct replacements for conventional nuts and bolts. These devices can be threaded onto a new or existing bolt, stud, threaded rod or shaft. The main thread serves to position the tensioner on the bolt or stud against the hardened washer and the load-bearing surface. Once it is positioned, actual tensioning of the bolt or stud is accomplished with simple hand tools by torquing the jackbolts which encircle the main thread. The jackbolts transfer the preload evenly into the main thread and, consequently, onto the joint. The main thread is tightened in pure tension.

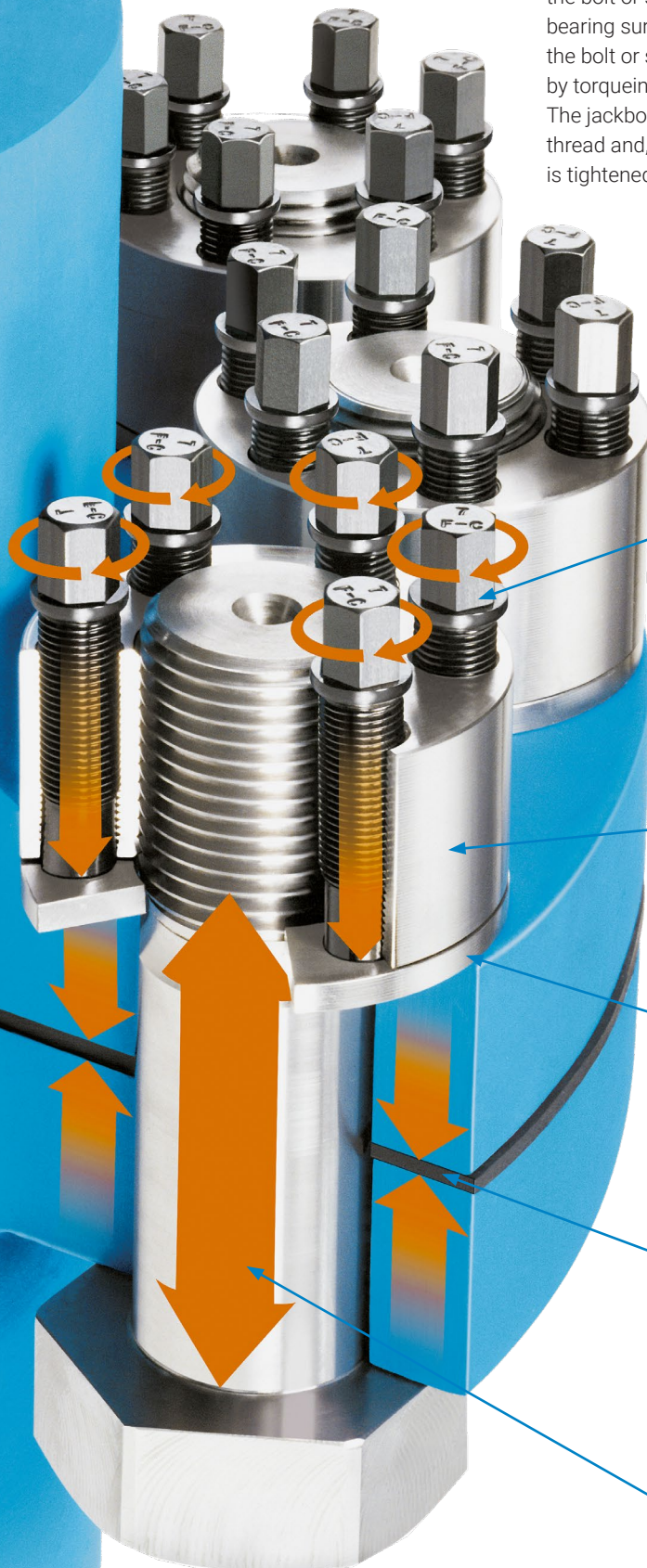

**1** By tightening the jackbolts, a strong thrust (axial) force is generated. This thrust force is directed against a hardened washer. Jackbolts have a small friction diameter and can therefore create a high thrust force with relatively little torque input.

**2** The loads are transferred through the nut body which is positioned on the main thread by hand.

**3** A hardened washer is used to transfer the force while protecting the flange face.

**4** The thrust (axial) force of jackbolts and the opposite reaction force of the main bolt head create a strong clamping force on the flange.

**5** The thrust (axial) force from the jackbolt creates an equally strong reaction force in the main bolt.

# A Full Lifespan of Advantages

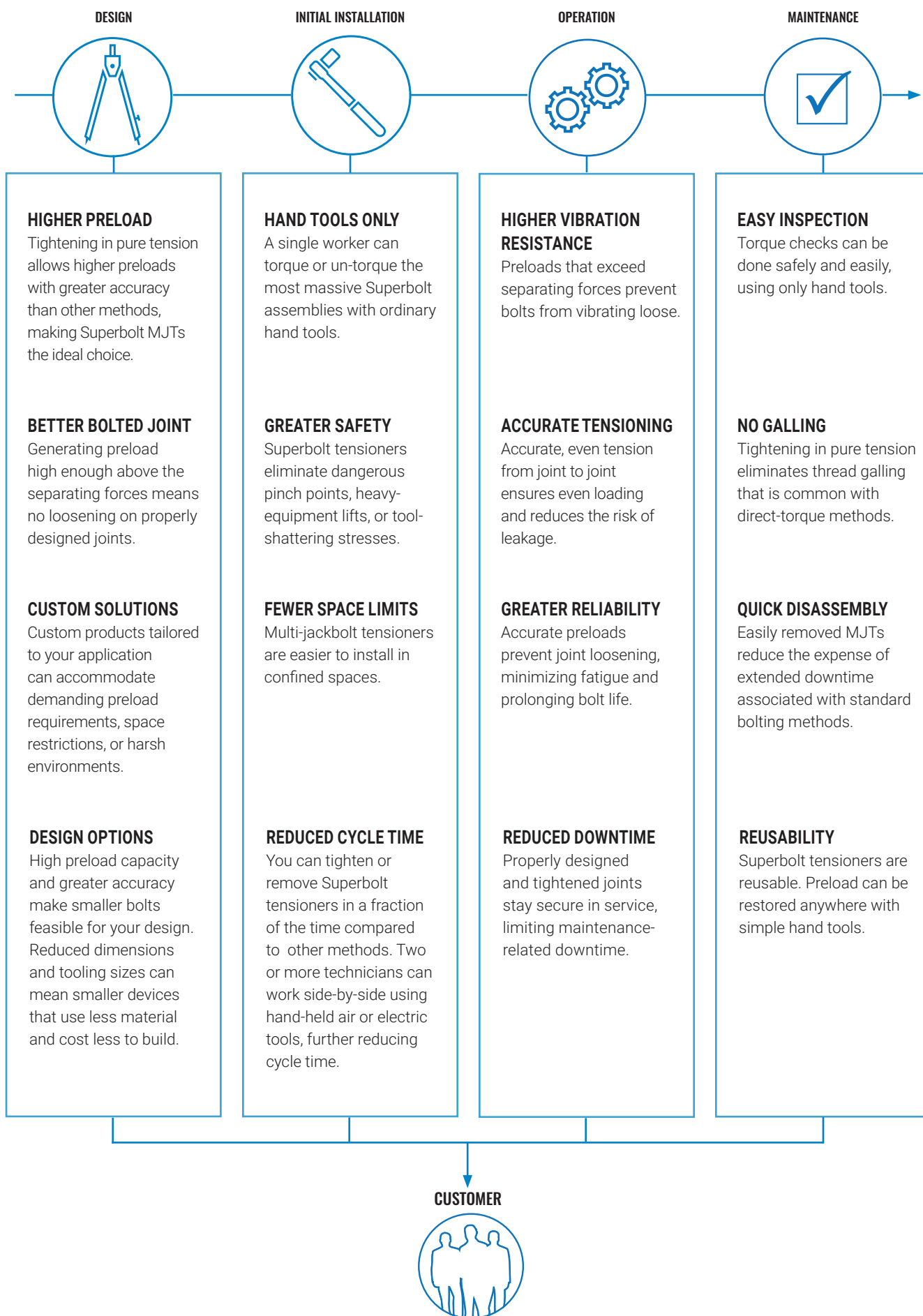



# EXPERIENCED ENGINEERS AND TOTAL CUSTOMER SUPPORT

From design and manufacturing to installation and operation, our expertise is at your service through our global network of sales offices. Find yours at [nord-lock.com](http://nord-lock.com).



*Protect your investment by using Superbolt-recommended accessories and consumables.*

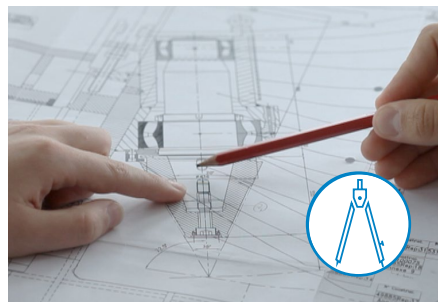

## Accessories and consumables

The wrong parts, tools, and materials can reduce the function of Superbolt tensioners or cause direct and indirect damage. You can protect your investment in safe bolted connections by using high-quality, Superbolt-recommended accessories and consumables, including:

- Lubricants
- Sockets
- Pneumatic/electric wrenches
- Protective caps
- Torque wrenches

## Instruction manuals

To ensure correct assembly, and increase safety, speed, and service life, we include a complete installation and removal manual with every Superbolt tensioner shipment. You can access the same useful information anywhere, anytime in PDF or video form at [www.superbolt.com](http://www.superbolt.com). For further info on using, applying and maintaining Superbolt tensioners, contact your local Nord-Lock sales office.

## Engineering support

Joint calculation & verification, product development, customer unique with tailored designs, calculation sheets, finite element analysis, and more. Contact us for preload monitoring options for on-site service with high value.

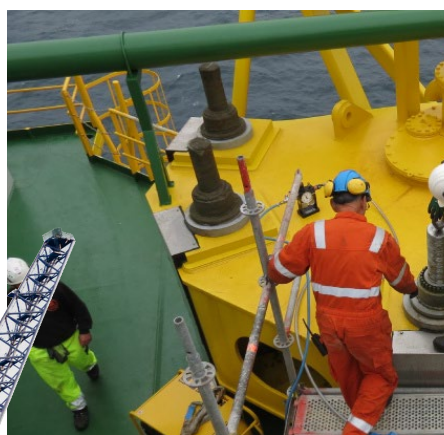

## Installation assistance

Our expertise is at your service. When you need backup, trained Superbolt technicians can:

- Train your team
- Support your team during installations
- Perform/assist with installations



## Joint design and installation



### STUD BOLTS

Superbolt nut-style tensioners may be used on studs into blind-tapped holes. Tightening in pure tension means studs will not gall in the tapped hole and can be easily removed.



### TAPPED HOLES

Superbolt bolt-style tensioners are often used into blind-tapped holes. MJT bolt heads are more compact and fit into tighter areas; additionally they reduce the number of parts.



### THROUGH-HOLES

A common application of double-ended studs uses Superbolt nut-style tensioners and a reaction nut (Flexnut) on the other end. Flexnuts add elasticity to the stud, increasing the fatigue life.

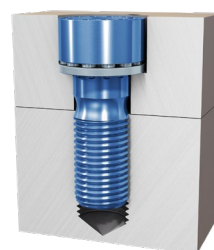

### COUNTER BORES

Superbolt bolt-style tensioners can be provided to fit completely into small counterbores. An internal installation removal hex allows for easy turning into position.

## Helpful tips

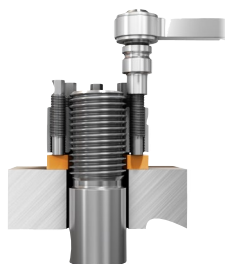

### CENTERING OF WASHER ON THREAD

Make sure the washer is not resting on one side of undercuts or radius of mating studs.

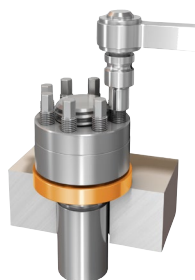

### MATERIAL WITH LOW STRENGTH

A thicker/larger washer or an additional washer may be necessary when materials with low strength are used on the joint.



### LARGE OR SLOTTED HOLES

An additional washer or a large washer is necessary to transfer the bolt load to a supported surface.

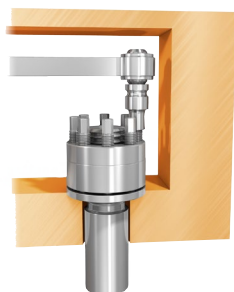

### SPACE REQUIREMENTS

Check for space restrictions when using a socket and wrench combination.



### TENSIONER AT THE END OF STUD

An additional distance spacer may be necessary to bring tensioner closer to the end of the stud for proper socket fit.

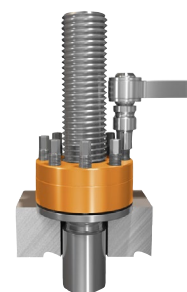

### VERY LONG THROUGH-STUD

A special tensioner with a larger circle of jackbolts may be necessary to properly access the jackbolts for tightening.

*If your application corresponds to one or more of the above mentioned design criteria, we will help you find the best solution.*



# WE'VE GOT THE GLOBAL MARKET COVERED



## PRESSES

Press columns, tie rods, bearing blocks, high pressure piping, die cushions, cylinder ram bolting, anchorbolts and more.



## OIL, GAS & PETROCHEMICAL

Top drives, blow out preventors, mud pumps, fracturing pumps, reactor covers, heat exchanger heads, turbine control valves, turbine joints, pipe flanges, anchorbolts, couplings and more.



## GAS COMPRESSION

Crosshead jamnuts, counterweight crosshead jamnuts, couplings, connecting rod nuts, distance pieces, end plates, compressor cylinders, doghouse bolting, piston end nuts, valve jackbolts and more.

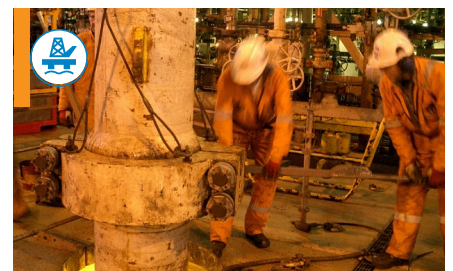
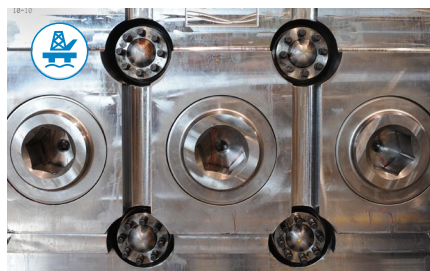
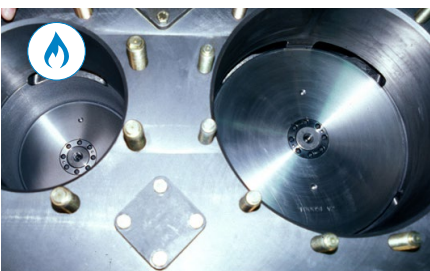

# THE TOUGHER YOUR PROBLEM, THE MORE WE LIKE IT

Visit *Cutting-edge solutions (p.54)* for more inspiration or contact us for detailed support.

## MINING



**Boom points, ring gears, side frames, hoist motors, pedestal tie-downs, drag-lines, pinion gears, hoist and drag drums, split gears, bolted segments, excavator bearing caps and more.**

## POWER GENERATION



**Including nuclear, wind, hydroelectric, fossil, and other. Turbine couplings, stay rods, manway doors, inlet flanges, boiler pump, main flange, boiler feed pump head, barrel casing, blade bolts, pelton turbine nozzles, servo piston nuts, and more.**

## STEEL MILLS



**Thrust collars, coupling bolts, tie rod nuts, anchor bolts, mill motors, bearings, shaft mounts, roll tables, BOF and EAF applications, coilers, hydraulic cylinders, cranes, slitter knives, universal joints, back-up roll bearings, work roll bearings, pipe mills and more.**





---

# INNOVATIVE AND PROVEN

## NO WONDER WE'RE CALLED SUPERBOLT

---

Superbolt products are proven in every major industry. Tested in the field, our tensioners are preferred for space, mining, oil and gas, petrochemical, forging and presses, power generation, marine propulsion, and many other industry-specific applications. Customer-focused solutions that optimize the bolting process from start to finish have made Superbolt the trusted choice worldwide.

Our engineers go to work each day determined to take on the world's most difficult bolting challenges. We are the first to offer a full lifecycle warranty for Superbolt technology, enabling engineers to shape modern living in the decades to come.

### World-class manufacturer

---

Superbolt products meet the industry's highest standards. They're manufactured at our state-of-the-art facilities in Pittsburgh, Pa., USA, and St. Gallenkappel, Switzerland, where advanced CNC machining allows exceptional precision and quick turnaround. Most standard products are available off-the-shelf or within short lead times. Quality control, including thread-gauging and measurement systems, is standard operating procedure, and every multi-jackbolt tensioner is marked for traceability.

### Project engineering

---

Our in-house engineering team provides a center of continuous product innovation, grounded in decades of bolted-joint know-how. Superbolt's design expertise extends into dozens of industries, where we've gained specialized knowledge – and numerous certifications – by solving difficult bolting challenges.

### Speaking your language

---

Our parent company, Nord-Lock Group, is a global leader in secure bolting solutions with an international network of sales offices and partners. Superbolt has representation in 65+ countries.





DISCOVER THE SUPERBOLT SOLUTION  
DESIGNED FOR YOUR BOLTING CHALLENGES

# TORQUE OR UN-TORQUE MASSIVE ASSEMBLIES WITH ORDINARY HAND TOOLS

IF YOU'RE NOT  
USING SUPERBOLT  
TENSIONERS,  
YOU'RE WORKING  
TOO HARD.



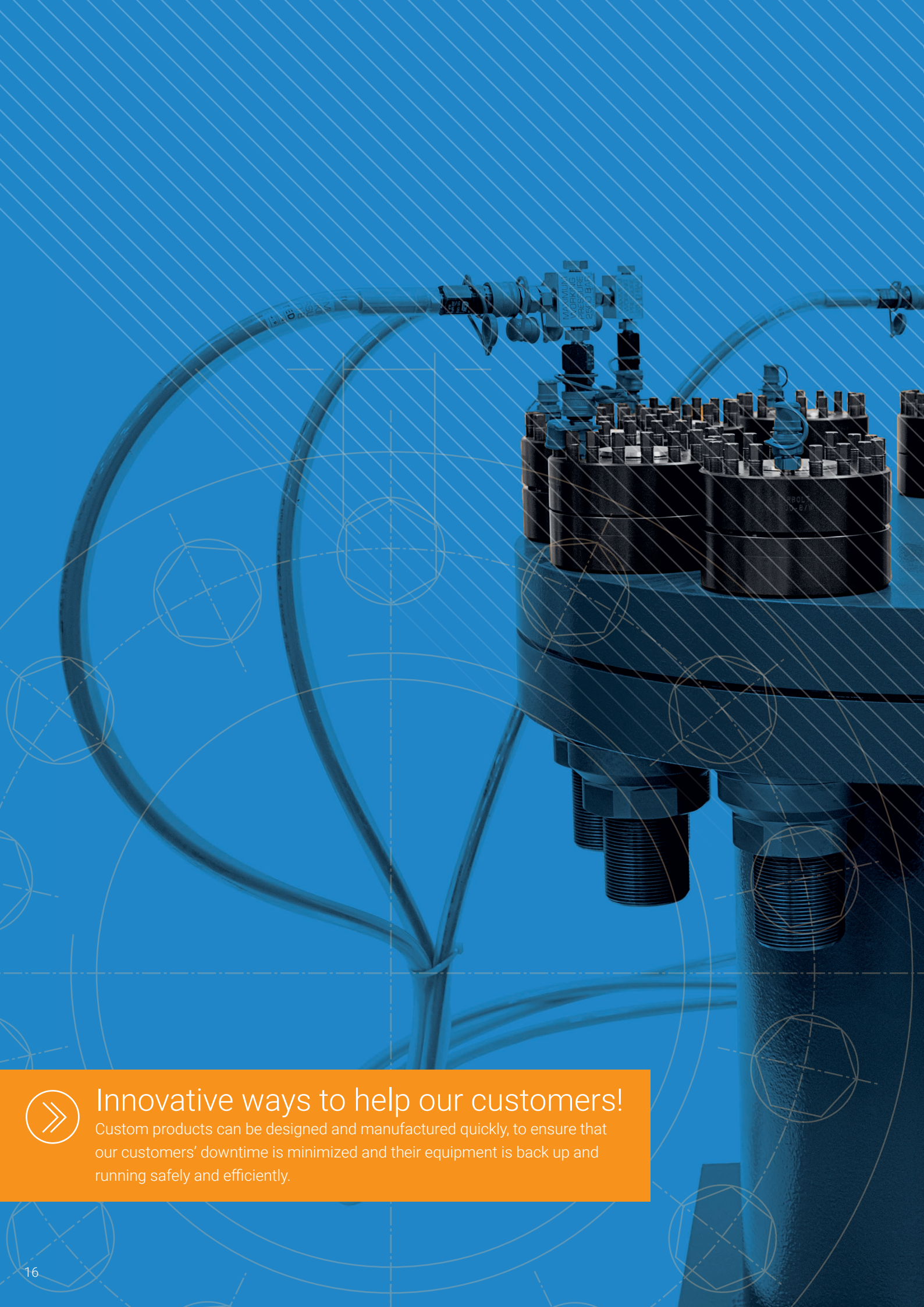

## Innovative ways to help our customers!

Custom products can be designed and manufactured quickly, to ensure that our customers' downtime is minimized and their equipment is back up and running safely and efficiently.



# NEWS & INNOVATIONS

From day one, innovation has been synonymous with Superbolt. Today, we continue to lead the way as evidenced in our newest product lines: **Global Standard GT/GTS Series Tensioners**, **VersaTite Hydraulic Mechanical Tensioners**, **EzFit Mechanical Expansion Bolts**, and **HyFit Hydraulic Expansion Bolts**.

Read on to learn more about these groundbreaking offerings, and count on Superbolt to continue advancing bolting technology...now and well into the future.





# BEST OF BOTH WORLDS IN A NEW RANGE

Introducing the new  
global tensioning range



Superbolt is proud to introduce the new GT range – a merging of our MT and CY lines, offering the best of both worlds. This new range provides numerous advantages to a broad application base:

- Range standardization, as all sizes follow the global standard, streamlined for ISO 898 compatibility.
- Shortened lead time and increased stocking globally.
- Increased mechanical advantage, which includes optimized load and torque output.
- And more!

## THE NEW GLOBAL TENSIONING RANGE

# GT

## NEW RANGE, ENHANCED MATERIAL & CAPABILITIES.

The all-new GT Mechanical Tensioner series from Superbolt is your go-to bolting solution for common high-strength studs and bolts found throughout industry. The GT is well-suited for the toughest of applications, enabling you to achieve high bolt loads safely and with ease. They are compatible for use on 8.8, 10.9 or equivalent-grade studs and bolts.

### GTS

Also available: new GTS super-duty mechanical tensioners, designed for super high-strength load applications on 10.9, 12.9 or equivalent studs and bolts!





# VERSATITE SPEED, UNIFORMITY AND ACCURACY.

Mechanical tensioners. Hydraulic tensioners. Each has its advantages. But what if one product could incorporate the strengths of both approaches?

That combination is here, in the groundbreaking new VersaTite Hydraulic Mechanical Tensioner. Now you can attain the speed and uniformity of a hydraulic tensioner with the accuracy of a mechanical tensioner.

# TWO TECHNOLOGIES IN ONE SYSTEM



VersaTite,  
the latest generation  
in tightening solutions.

**NEW!**

Hydraulically pressurized VersaTite delivers a fast, uniform initial preload. The design lets you accurately control the final preload mechanically by applying torque to a system of jackbolts. Removal method is up to you – mechanical or hydraulic.

- Depending on location, number of fasteners, space constraints, time, and availability of tooling, your operator can choose either mechanical or hydraulic removal.
- VersaTite incorporates reliable Boltight hydraulic tensing with state-of-the art seal and pressure design.
- The achieved preload is easily controlled by applying the final torque mechanically with Superbolt multi-jackbolt tensing.



# COUPLING BOLTING MADE SIMPLE

EzFit, the mechanical way to easily bolt coupling flanges together.



**NEW  
NAME!**

The innovative EzFit coupling bolt from Superbolt provides fast and accurate coupling maintenance using simple hand tools.

- Truly fitted bolt ensures optimum drive and prevents coupling slippage.
- Reusable – installed and removed in clearance condition.
- No bolt or coupling hole damage.
- Generous hole tolerance and split sleeve expansion minimize requirement for on-site hole preparation.

# EZFIT SIMPLER, LOWER-COST, BOLT REPLACEMENT.

Incorporating Superbolt technology, EzFit mechanical expansion bolt is able to offer tremendous radial expansion and joint clamping power in one bolting system. The expansion bolts replace traditional interference or force-fit bolts. The key to this solution is the split expansion sleeve that mates with the customer's machined holes. The split sleeve requires less tolerance on mating parts than is traditionally required with interference fit, saving critical machining time.



# HYFIT COUPLING CHALLENGES RESOLVED.

HyFit, the hydraulically operated expansion bolt by Superbolt, has been designed to address safety concerns expressed by many current users of hydraulic coupling bolts. In also providing the solution for coupling maintenance where standard-type “fitted” bolts cause major outage delays, its application solves most large coupling bolt issues in a totally unique package. HyFit is ideal for steam turbines, gas turbines, marine propulsion drives and all heavy rotating equipment plants. Benefits include:

- Truly fitted bolt
- Easily installed and removed in clearance condition
- Accommodates varying hole sizes
- Provides accurate maintenance scheduling
- Fully reusable – only requires sleeve replacement in the case of rotor change
- No bolt/hole damage, no re-work required

# SUPERIOR HYDRAULIC COUPLING BOLT

HyFit, the new advanced hydraulic expansion bolt.

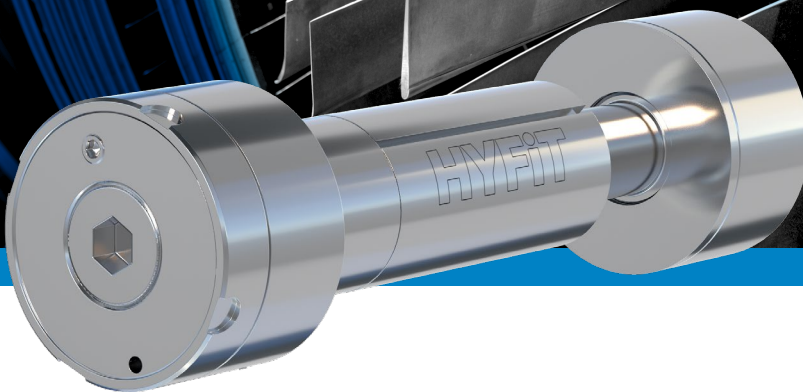

**NEW!**

HyFit delivers high-performance torque transmission for critical-load rotating shafts and couplings. It's an advanced solution for every coupling that requires truly fitted bolts:

- Reduce maintenance costs.
- Improve efficiency.
- Maximize plant availability.
- Minimize coupling breakout/make-up times.
- Quickly and easily regain alignment and concentricity.
- Increase peace of mind.





## Reliable from start to finish

Our engineering team can help you determine your bolted joint's critical dimensions and load conditions to ensure a reliable and cost-effective solution.



## COMMON APPLICATIONS

- Mining equipment
- Anchor bolts
- Gearboxes
- Crushers
- Compressors
- Presses
- Flange connections
- Split gears

# STANDARD NUT & BOLT-STYLE TENSIONERS

**When it comes to standard nut & bolt-style tensioners, Superbolt has got you covered for a wide range of applications across all industries.**

The GT and GTS Series, Superbolt's newest lines, provide range standardization that offers global feasibility, increased mechanical advantage, and more to a broad application base.

The MT and SB8 Series offer nut and bolt-style solutions for general mechanical applications, while the CY and SB12 Series provide solutions for high preload applications.

Medium-temperature applications are best suited for Superbolt's H650 Series, though the H650T Series is ideal for use where space is limited.





# GT

## Nut-style tensioner

### standard- & high-strength

GT Series Tensioners are used for standard- and high-strength bolt loads on many general mechanical applications. Suitable as ISO 898-2 class 8 replacement for use on grades 8.8 or equivalent stud/bolts.

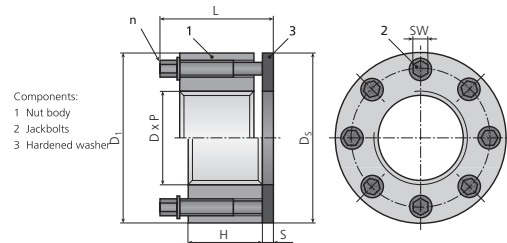

Metric and imperial		Size	Available pitch or TPI			Nut body		Jackbolt		Hardened washer		Height	Weight	70% of 8.8 yield strength (reference)*		Preload capacity*
Part group	Part number	Thread D [mm] or [in.]	P <sub>1</sub>	P <sub>2</sub>	P <sub>3</sub>	D <sub>1</sub> [mm]	H [mm]	n	2 SW [mm]	D <sub>s</sub> [mm]	S [mm]	tot L [mm]	est [kg]	Preload F [kN]	Torque M [Nm]	max [kN]
1	GT-M16x.../W	M16	2	1.5	1	37	17	6	5	37	4	34	0.16	70	9	145
	GT-075-.../W	3/4	10	16	—								0.15	100	13	145
2	GT-M20x.../W	M20	2.5	1.5	1	40	18	8	5	40	4	34	0.19	110	11	190
	GT-M22x.../W	M22	2.5	1.5	1								0.18	135	13	190
3	GT-087-.../W	7/8	9	14	—	50	23	6	6	50	5	45	0.18	135	13	190
	GT-M24x.../W	M24	3	2	1.5								0.39	160	27	290
4	GT-100-.../W	1	8	12	14	50	23	6	6	50	5	45	0.38	175	30	290
	GT-M27x.../W	M27	3	2	1.5								0.36	205	35	290
5	GT-112-.../W	1-1/8	7	8	12	53	25	7	6	53	5	45	0.43	225	32	340
	GT-M30x.../W	M30	3.5	2	1.5								0.41	250	36	340
6	GT-125-.../W	1-1/4	7	8	12	62	28	6	8	62	6	58	0.72	285	59	455
	GT-M33x.../W	M33	3.5	2	1.5								0.70	310	65	455
7	GT-137-.../W	1-3/8	6	8	12	65	32	7	8	65	6	58	0.83	335	61	535
	GT-M36x.../W	M36	4	3	1.5								0.81	365	66	535
8	GT-150-.../W	1-1/2	6	8	12	71	32	8	8	71	6	58	0.97	410	65	610
	GT-M39x.../W	M39	4	3	1.5								0.96	435	69	610
9	GT-162-.../W	1-5/8	6	8	12	75	32	9	8	75	6	58	1.06	485	68	685
	GT-M42x.../W	M42	4.5	3	1.5								1.05	500	70	685
10	GT-175-.../W	1-3/4	5	8	12	83	38	7	10	83	8	70	1.58	555	119	820
	GT-M45x.../W	M45	4.5	3	1.5								1.56	585	126	820
11	GT-187-.../W	1-7/8	6	8	12	89	38	8	10	89	8	70	1.83	670	126	935
	GT-M48x.../W	M48	5	3	1.5								1.82	660	124	935
12	GT-200-.../W	2	4.5	8	12	91	38	9	10	91	8	70	1.90	730	122	1,050
	GT-M52x.../W	M52	5	3	2								1.86	785	132	1,050
13	GT-M56x.../W	M56	5.5	4	2	102	50	9	12	102	8	85	2.93	910	177	1,400
	GT-225-.../W	2-1/4	4.5	8	12								2.88	945	184	1,400
14	GT-M60x.../W	M60	5.5	4	2	111	57	8	14	111	10	101	2.77	1,060	206	1,400
	GT-250-.../W	2-1/2	4	8	12								3.99	1,160	290	1,700
15	GT-M64x.../W	M64	6	4	2	118	57	9	14	118	10	101	3.96	1,200	299	1,700
	GT-M68x.../W	M68	6	4	2								4.49	1,370	303	1,910
16	GT-275-.../W	2-3/4	4	8	12	124	62	10	14	124	10	101	4.38	1,440	318	1,910
	GT-M72x.../W	M72	6	4	2								5.13	1,550	309	2,120
17	GT-M76x.../W	M76	6	4	2	133	62	13	14	133	10	101	4.86	1,740	347	2,120
	GT-300-.../W	3	4	6	8								4.85	1,740	346	2,120
18	GT-M80x.../W	M80	6	4	2	144	72	12	16	144	12	116	5.87	1,950	299	2,760
	GT-325-.../W	3-1/4	4	6	8								5.68	2,060	317	2,760
19	GT-M85x.../W	M85	6	4	2	151	75	13	16	151	12	116	8.06	2,220	413	3,330
	GT-350-.../W	3-1/2	4	6	8								7.71	2,420	451	3,330
20	GT-M90x.../W	M90	6	4	2	163	75	15	16	163	12	116	8.98	2,500	431	3,610
	GT-375-.../W	3-3/4	4	6	8								8.45	2,810	483	3,610
21	GT-M100x.../W	M100	6	4	2	178	102	15	17	178	12	146	10.07	3,130	467	4,160
	GT-400-.../W	4	4	6	8								9.90	3,220	480	4,160
22	GTX2-425-.../W	4-1/4	4	6	8	193	102	18	17	193	12	146	16.18	3,660	331	5,250
	GTX2-M110x.../W	M110	6	4	2								15.86	3,830	347	5,250
23	GTX2-450-.../W	4-1/2	4	6	8	203	114	20	17	203	12	161	19.58	4,130	311	6,300
	GTX2-M120x.../W	M120	6	4	2								18.64	4,600	347	6,300
24	GTX2-475-.../W	4-3/4	4	6	8	211	114	22	17	211	12	161	18.53	4,630	349	6,300
	GTX2-M125x.../W	M125	6	4	2								22.29	5,010	340	7,010
25	GTX2-500-.../W	5	4	6	8	220	127	18	21	220	16	185	21.90	5,150	350	7,010
	GTX2-M130x.../W	M130	6	4	2								24.04	5,440	336	7,710
26	GTX2-525-.../W	5-1/4	4	6	8	240	132	20	21	240	16	185	23.35	5,710	352	7,710
	GTX2-550-.../W	5-1/2	4	6	8								29.17	6,290	572	8,850
27	GTX2-M140x.../W	M140	6	4	2	270	132	23	21	270	16	185	29.10	6,350	578	8,850
	GTX2-575-.../W	5-3/4	4	6	8								36.87	6,910	565	9,840
28	GTX2-M150x.../W	M150	6	4	2	270	132	23	21	270	16	185	35.81	7,330	600	9,840
	GTX2-600-.../W	6	4	6	8								49.68	7,550	537	11,310
29	GTX2-M160x.../W	M160	6	4	—	270	132	23	21	270	16	185	47.51	8,380	597	11,310

\* All preload and torque values are provided for general reference. Applied preload plus additional bolt load from service should not exceed the maximum bolt or stud capacity. Contact your local Nord-Lock sales office for assistance in determining proper preload and torque settings for your application.  
 - Sizes over M100 or 4" become "GTX2" and use LB 8012 lube for reduced torque values.  
 - Other sizes, thread pitches or thread per inch (TPI) may be available.  
 - Dimensions listed are representative.

# GTS

## Nut-style tensioner super high-strength

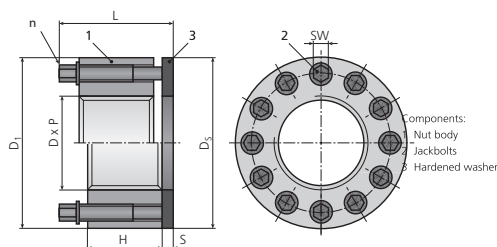

GTS Series Tensioners are used for super-high-strength bolt loads on general mechanical applications.  
Suitable as ISO 898-2 class 10 replacement for use on grades 10.9 or equivalent stud/bolts.

Metric and imperial		Size			Nut body		Jackbolt		Hardened washer		Height	Weight	70% of 10.9 yield strength (reference)*		Preload capacity*	
Part group	Part number	Thread D [mm] or [in.]	Available pitch or TPI			1		2		3		tot L [mm]	est [kg]	Preload F [kN]	Torque M [Nm]	max [kN]
			P <sub>1</sub>	P <sub>2</sub>	P <sub>3</sub>	D <sub>1</sub> [mm]	H [mm]	n	SW [mm]	D <sub>s</sub> [mm]	S [mm]					
1	GTS-M16x.../W	M16	2	1.5	1	42	25	4	6	42	5	45	0.32	105	26	195
	GTS-075.../W	3/4	10	16	—								0.30	145	36	195
2	GTS-M20x.../W	M20	2.5	1.5	1	46	25	6	6	46	5	45	0.36	160	27	290
	GTS-M22x.../W	M22	2.5	1.5	1	46	25	6	6	46	5	45	0.35	200	34	290
	GTS-087.../W	7/8	9	14	—								0.35	200	33	290
3	GTS-M24x.../W	M24	3	2	1.5								0.46	230	26	435
	GTS-100.../W	1	8	12	14	51	25	9	6	51	5	45	0.46	260	29	435
	GTS-M27x.../W	M27	3	2	1.5								0.44	300	34	435
4	GTS-112.../W	1-1/8	7	8	12	60	31	7	8	60	6	58	0.75	325	59	535
	GTS-M30x.../W	M30	3.5	2	1.5								0.73	370	66	535
5	GTS-125.../W	1-1/4	7	8	12	64	32	8	8	64	6	58	0.85	415	65	610
	GTS-M33x.../W	M33	3.5	2	1.5								0.83	455	72	610
6	GTS-137.../W	1-3/8	6	8	12	68	32	10	8	68	6	58	0.95	495	62	760
	GTS-M36x.../W	M36	4	3	1.5								0.93	535	68	760
7	GTS-150.../W	1-1/2	6	8	12	75	38	8	10	75	8	70	1.41	600	113	935
	GTS-M39x.../W	M39	4	3	1.5								1.39	640	121	935
8	GTS-162.../W	1-5/8	6	8	12	79	39	9	10	79	8	70	1.58	715	119	1,050
	GTS-M42x.../W	M42	4.5	3	1.5								1.56	735	123	1,050
9	GTS-175.../W	1-3/4	5	8	12	83	40	10	10	83	8	70	1.72	815	122	1,170
	GTS-M45x.../W	M45	4.5	3	1.5								1.71	860	129	1,170
10	GTS-187.../W	1-7/8	6	8	12	90	46	9	12	90	8	85	2.38	985	192	1,400
	GTS-M48x.../W	M48	5	3	1.5								2.37	970	189	1,400
11	GTS-200.../W	2	4.5	8	12	95	47	10	12	95	8	85	2.69	1,070	188	1,560
	GTS-M52x.../W	M52	5	3	2								2.64	1,160	203	1,560
12	GTS-M56x.../W	M56	5.5	4	2								3.08	1,340	195	1,870
	GTS-225.../W	2-1/4	4.5	8	12	102	50	12	12	102	8	85	3.04	1,390	203	1,870
13	GTS-M60x.../W	M60	5.5	4	2								4.53	1,550	282	2,330
	GTS-250.../W	2-1/2	4	8	12	112	59	11	14	112	10	101	4.35	1,710	310	2,330
14	GTS-M64x.../W	M64	6	4	2								4.84	1,760	293	2,550
	GTS-M68x.../W	M68	6	4	2								4.93	2,010	308	2,760
15	GTS-275.../W	2-3/4	4	8	12	125	62	14	14	125	10	101	5.62	2,110	301	2,970
	GTS-M72x.../W	M72	6	4	2								5.48	2,280	324	2,970
16	GTS-M76x.../W	M76	6	4	2								6.90	2,560	319	3,390
	GTS-300.../W	3	4	6	8	138	62	16	14	138	10	101	6.89	2,550	318	3,390
17	GTS-M80x.../W	M80	6	4	2								8.10	2,860	457	3,880
	GTS-325.../W	3-1/4	4	6	8	152	72	16	16	152	12	116	10.02	3,030	424	4,440
18	GTS-M85x.../W	M85	6	4	2								9.81	3,260	455	4,440
	GTS-350.../W	3-1/2	4	6	8	160	75	17	16	160	12	116	10.94	3,550	468	4,720
19	GTS-M90x.../W	M90	6	4	2								10.83	3,680	484	4,720
	GTS-375.../W	3-3/4	4	6	8	167	75	18	16	167	16	120	12.38	4,120	512	4,990
20	GTS-M100x.../W	M100	6	4	2								15.94	4,600	515	5,550
	GTS-400.../W	4	4	6	8	186	75	20	16	186	16	120	15.75	4,730	529	5,550

\* All preload and torque values are provided for general reference. Applied preload plus additional bolt load from service should not exceed the maximum bolt or stud capacity.  
Contact your local Nord-Lock sales office for assistance in determining proper preload and torque settings for your application.

- Other sizes, thread pitches or thread per inch (TPI) may be available.

- Dimensions listed are representative.



# MT

## Nut-style tensioner standard

MT tensioners fit in the same space as a heavy hex nut and feature hex-head jackbolts. They're suited for use on general mechanical applications.

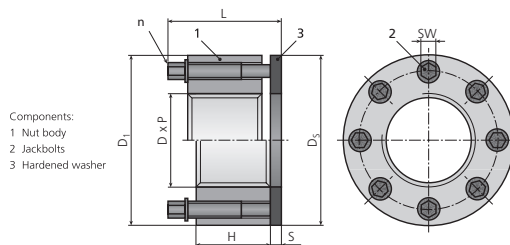

Metric	Size			Nut body		Jackbolt		Hardened washer		Height tot	Weight est	Preload* nom	Torque* nom	Preload capacity* max	
	Thread	Available pitch			1	2	3	3							
Part number	D [mm]	P <sub>1</sub> [mm]	P <sub>2</sub>	P <sub>3</sub>	D <sub>1</sub> [mm]	H [mm]	n	SW [mm]	D <sub>s</sub> [mm]	S [mm]	L [mm]	F [kN]	M [Nm]	[kN]	
MT-M16x.../W	M16	2	1.5	1	34	16	4	5	32	3	33	0.11	73	14	94
MT-M20x.../W	M20	2.5	1.5	1	38	16	6	5	38	4	34	0.14	110	14	140
MT-M22x.../W	M22	2.5	1.5	1	41	16	6	5	41	4	34	0.16	110	14	140
MT-M24x.../W	M24	3	2	1.5	44	16	8	5	43	4	34	0.19	145	14	185
MT-M27x.../W	M27	3	2	1.5	50	24	6	6	50	5	45	0.35	215	36	285
MT-M30x.../W	M30	3.5	2	1.5	53	24	6	6	53	5	45	0.37	215	36	285
MT-M33x.../W	M33	3.5	2	1.5	59	24	8	6	59	5	45	0.48	285	36	380
MT-M36x.../W	M36	4	3	1.5	66	32	6	8	66	5	57	0.76	345	72	460
MT-M39x.../W	M39	4	3	1.5	70	32	8	8	70	5	57	0.90	455	72	610
MT-M42x.../W	M42	4.5	3	1.5	75	32	8	8	73	5	57	1.01	455	72	610
MT-M45x.../W	M45	4.5	3	1.5	83	38	8	10	81	6	68	1.48	700	131	935
MT-M48x.../W	M48	5	3	1.5	85	38	8	10	85	6	68	1.50	700	131	935
MT-M52x.../W	M52	5	3	2	94	38	8	10	89	6	68	1.80	700	131	935
MT-M56x.../W	M56	5.5	4	2	100	38	8	10	95	6	68	2.00	700	131	935
MT-M60x.../W	M60	5.5	4	2	107	38	10	10	100	6	68	2.30	875	131	1170
MT-M64x.../W	M64	6	4	2	113	53	8	14	112	8	92	3.65	1270	315	1690
MT-M68x.../W	M68	6	4	2	117	53	8	14	117	8	92	3.85	1270	315	1690
MT-M72x.../W	M72	6	4	2	120	56	8	14	120	8	92	4.00	1270	315	1690
MT-M76x.../W	M76	6	4	2	132	56	12	14	127	8	92	5.10	1900	315	2530
MT-M80x.../W	M80	6	4	2	132	56	12	14	127	8	92	4.80	1900	315	2530
MT-M85x.../W	M85	6	4	2	137	56	12	14	137	8	92	5.10	1900	315	2530
MT-M90x.../W	M90	6	4	2	145	59	16	14	140	8	99	6.00	2530	315	3380
MT-M100x.../W	M100	6	4	2	164	61	16	14	152	8	99	7.80	2530	315	3380
MT-M110x.../W	M110	6	4	2	177	79	12	17	172	10	125	11.40	3150	645	4200
MT-M120x.../W	M120	6	4	2	189	81	16	17	179	10	125	13.00	4200	645	5600
MT-M125x.../W	M125	6	4	2	194	81	16	17	190	10	125	13.50	4200	645	5600
MT-M130x.../W	M130	6	4	2	205	94	18	17	202	10	140	17.50	4700	645	6300
MT-M140x.../W	M140	6	4	2	215	94	20	17	215	10	140	18.70	5250	645	7000
MT-M150x.../W	M150	6	4	2	225	94	20	17	225	12	142	20.00	5250	645	7000
MT-M160x.../W	M160	6	4	-	234	107	24	17	234	12	162	24.10	6300	645	8400

Imperial	Size			Nut body		Jackbolt		Hardened washer		Height tot	Weight est	Preload* nom	Torque* nom	Preload capacity* max	
	Thread	Available TPI			1	2	3	3							
Part number	D [in]	P <sub>1</sub>	P <sub>2</sub>	P <sub>3</sub>	D <sub>1</sub> [in]	H [in]	n	SW [in]	D <sub>s</sub> [in]	S [in]	L [in]	[Lb]	F [LBf]	M [LBft]	[LBf]
MT-075-.../W	3/4	10	16	-	1.47	0.70	4	3/16	1.50	0.13	1.38	0.31	20,400	14	27,200
MT-087-.../W	7/8	9	14	-	1.60	0.70	6	3/16	1.63	0.13	1.38	0.34	30,600	14	40,800
MT-100-.../W	1	8	12	14	1.90	0.93	6	1/4	2.00	0.19	1.71	0.68	48,600	27	64,800
MT-112-.../W	1-1/8	7	8	12	2.08	0.93	6	1/4	2.13	0.19	1.71	0.79	48,600	27	64,800
MT-125-.../W	1-1/4	7	8	12	2.25	0.94	8	1/4	2.38	0.19	1.71	0.92	64,800	27	86,400
MT-137-.../W	1-3/8	6	8	12	2.46	1.20	6	5/16	2.50	0.19	2.12	1.40	73,800	49	98,400
MT-150-.../W	1-1/2	6	8	12	2.70	1.20	8	5/16	2.75	0.19	2.12	1.70	98,400	49	131,200
MT-162-.../W	1-5/8	6	8	12	2.96	1.20	8	5/16	2.88	0.19	2.12	2.01	98,400	49	131,200
MT-175-.../W	1-3/4	5	8	12	3.08	1.42	8	3/8	3.13	0.25	2.49	2.53	129,600	75	172,800
MT-187-.../W	1-7/8	6	8	12	3.59	1.60	8	7/16	3.50	0.25	2.85	4.07	175,200	114	233,600
MT-200-.../W	2	4.5	8	12	3.59	1.60	8	7/16	3.50	0.25	2.85	3.87	175,200	114	233,600
MT-225-.../W	2-1/4	4.5	8	12	3.95	1.60	8	7/16	3.75	0.25	2.85	4.51	175,200	114	233,600
MT-250-.../W	2-1/2	4	8	12	4.45	2.10	8	9/16	4.50	0.31	3.61	7.82	285,600	233	380,800
MT-275-.../W	2-3/4	4	8	12	4.70	2.10	8	9/16	4.75	0.31	3.61	8.36	285,600	233	380,800
MT-300-.../W	3	4	6	8	5.20	2.10	12	9/16	5.00	0.31	3.61	10.30	428,400	233	571,200
MT-325-.../W	3-1/4	4	6	8	5.45	2.20	12	9/16	5.00	0.31	3.61	11.04	428,400	233	571,200
MT-350-.../W	3-1/2	4	6	8	5.70	2.30	16	9/16	5.50	0.31	3.87	12.62	571,200	233	761,600
MT-375-.../W	3-3/4	4	6	8	6.20	2.40	16	9/16	5.50	0.31	3.87	15.08	571,200	233	761,600
MT-400-.../W	4	4	6	8	6.45	2.60	18	9/16	6.00	0.31	4.19	17.31	642,600	233	856,800
MT-425-.../W	4-1/4	4	6	8	6.95	3.00	16	5/8	6.40	0.38	4.76	23.41	806,400	390	1,075,200
MT-450-.../W	4-1/2	4	6	8	7.20	3.00	16	5/8	6.65	0.38	4.76	24.44	806,400	390	1,075,200
MT-475-.../W	4-3/4	4	6	8	7.45	3.20	18	5/8	6.90	0.38	5.06	27.13	907,200	390	1,209,600
MT-500-.../W	5	4	6	8	7.70	3.30	20	5/8	7.15	0.38	5.06	28.83	1,008,000	390	1,344,000
MT-525-.../W	5-1/4	4	6	8	8.45	3.70	22	5/8	7.65	0.38	5.36	40.06	1,108,800	390	1,478,400
MT-550-.../W	5-1/2	4	6	8	8.45	3.70	22	5/8	7.65	0.38	5.36	37.56	1,108,800	390	1,478,400
MT-575-.../W	5-3/4	4	6	8	8.95	4.00	24	5/8	8.15	0.38	5.76	46.26	1,209,600	390	1,612,800
MT-600-.../W	6	4	6	8	8.95	4.00	24	5/8	8.15	0.38	5.76	43.32	1,209,600	390	1,612,800

\* All preload and torque values are provided for general reference. Applied preload plus additional bolt load from service should not exceed the maximum bolt or stud capacity. Contact your local Nord-Lock sales office for assistance in determining proper preload and torque settings for your application.  
 - Other sizes, thread pitches or thread per inch (TPI) may be available.  
 - Dimensions listed are representative.

# CY Nut-style tensioner high strength

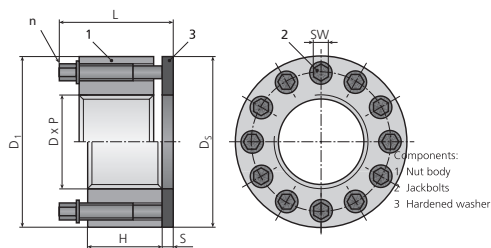

CY series tensioners are used for high strength bolt loads on general machinery applications. They fit in the same space as a heavy hex nut.

Metric	Size			Nut body		Jackbolt		Hardened washer		Height tot	Weight est	Preload* nom	Torque* nom	Preload capacity* max	
	Thread	Available Pitch			1		2		3						
Part number	D [mm]	P <sub>1</sub> [mm]	P <sub>2</sub>	P <sub>3</sub>	D <sub>1</sub> [mm]	H [mm]	n	SW [mm]	D <sub>s</sub> [mm]	S [mm]	L [mm]	F [kN]	M [Nm]	[kN]	
CY-M16x.../W	M16	2	1.5	1	34	16	6	5	32	3	33	0.12	110	14	140
CY-M20x.../W	M20	2.5	1.5	1	38	17	8	5	38	4	34	0.15	145	14	185
CY-M22x.../W	M22	2.5	1.5	1	41	17	8	5	41	4	34	0.17	145	14	185
CY-M24x.../W	M24	3	2	1.5	47	24	6	6	47	4	44	0.30	215	36	285
CY-M27x.../W	M27	3	2	1.5	51	24	8	6	50	5	45	0.37	285	36	380
CY-M30x.../W	M30	3.5	2	1.5	54	24	8	6	53	5	45	0.38	285	36	380
CY-M33x.../W	M33	3.5	2	1.5	62	32	6	8	61	5	57	0.70	345	72	460
CY-M36x.../W	M36	4	3	1.5	66	32	8	8	66	5	57	0.79	455	72	610
CY-M39x.../W	M39	4	3	1.5	72	32	10	8	70	5	57	0.97	570	72	760
CY-M42x.../W	M42	4.5	3	1.5	76	32	12	8	73	5	57	1.10	685	72	915
CY-M45x.../W	M45	4.5	3	1.5	81	38	8	10	80	6	68	1.40	700	131	935
CY-M48x.../W	M48	5	3	1.5	85	38	10	10	85	6	68	1.54	875	131	1170
CY-M52x.../W	M52	5	3	2	94	38	12	10	90	6	68	1.80	1050	131	1400
CY-M56x.../W	M56	5.5	4	2	98	38	12	10	94	6	68	1.93	1050	131	1400
CY-M60x.../W	M60	5.5	4	2	107	59	8	14	106	8	99	3.70	1270	315	1690
CY-M64x.../W	M64	6	4	2	113	59	10	14	112	8	99	4.10	1580	315	2100
CY-M68x.../W	M68	6	4	2	117	59	12	14	117	8	99	4.30	1900	315	2530
CY-M72x.../W	M72	6	4	2	121	59	12	14	120	8	99	4.50	1900	315	2530
CY-M76x.../W	M76	6	4	2	132	61	16	14	127	8	99	5.60	2530	315	3380
CY-M80x.../W	M80	6	4	2	133	61	16	14	127	8	99	5.40	2530	315	3380
CY-M85x.../W	M85	6	4	2	139	61	16	14	137	8	99	5.80	2530	315	3380
CY-M90x.../W	M90	6	4	2	145	61	16	14	140	8	99	6.30	2530	315	3380
CY-M100x.../W	M100	6	4	2	157	61	16	14	152	8	99	7.00	2530	315	3380
CY-M110x.../W	M110	6	4	2	177	61	20	14	163	8	99	9.00	3150	315	4200
CY-M120x.../W	M120	6	4	2	189	81	18	17	179	10	125	13.10	4700	645	6300
CY-M125x.../W	M125	6	4	2	194	81	18	17	190	10	125	13.70	4700	645	6300
CY-M130x.../W	M130	6	4	2	205	94	20	17	202	10	140	17.60	5250	645	7000
CY-M140x.../W	M140	6	4	2	215	94	22	17	215	10	140	18.89	5750	645	7700
CY-M150x.../W	M150	6	4	2	225	94	22	17	225	12	142	20.10	5750	645	7700
CY-M160x.../W	M160	6	4	-	226	107	24	17	220	10	160	20.80	6300	645	8400

Imperial	Size			Nut body		Jackbolt		Hardened washer		Height tot	Weight est	Preload* nom	Torque* nom	Preload capacity* max	
	Thread	Available TPI			1		2		3						
Part number	D [in]	P <sub>1</sub>	P <sub>2</sub>	P <sub>3</sub>	D <sub>1</sub> [in]	H [in]	n	SW [in]	D <sub>s</sub> [in]	S [in]	L [in]	F [Lbf]	M [Lbft]	[Lbf]	
CY-075.../W	3/4	10	16	-	1.47	0.70	6	3/16	1.50	0.13	1.38	0.31	30,600	14	40,800
CY-087.../W	7/8	9	14	-	1.70	0.70	8	3/16	1.63	0.13	1.38	0.39	40,800	14	54,400
CY-100.../W	1	8	12	14	1.90	0.93	6	1/4	2.00	0.19	1.71	0.68	48,600	27	64,800
CY-112.../W	1-1/8	7	8	12	2.08	0.93	8	1/4	2.13	0.19	1.71	0.78	64,800	27	86,400
CY-125.../W	1-1/4	7	8	12	2.32	1.20	6	5/16	2.38	0.19	2.12	1.30	73,800	49	98,400
CY-137.../W	1-3/8	6	8	12	2.46	1.20	8	5/16	2.50	0.19	2.12	1.42	98,400	49	131,200
CY-150.../W	1-1/2	6	8	12	2.80	1.42	8	3/8	2.75	0.19	2.43	2.11	129,600	75	172,800
CY-162.../W	1-5/8	6	8	12	2.96	1.42	8	3/8	2.88	0.19	2.43	2.29	129,600	75	172,800
CY-175.../W	1-3/4	5	8	12	3.20	1.42	12	3/8	3.13	0.25	2.49	2.80	194,400	75	259,200
CY-187.../W	1-7/8	6	8	12	3.59	1.60	8	7/16	3.50	0.25	2.85	4.07	175,200	114	233,600
CY-200.../W	2	4.5	8	12	3.70	1.60	12	7/16	3.50	0.25	2.85	4.24	262,800	114	350,400
CY-225.../W	2-1/4	4.5	8	12	3.95	1.60	12	7/16	3.75	0.25	2.85	4.59	262,800	114	350,400
CY-250.../W	2-1/2	4	8	12	4.45	2.30	12	9/16	4.50	0.31	3.87	8.64	428,400	233	571,200
CY-275.../W	2-3/4	4	8	12	4.70	2.40	12	9/16	4.75	0.31	3.87	9.45	428,400	233	571,200
CY-300.../W	3	4	6	8	5.20	2.30	16	9/16	5.00	0.31	3.87	11.33	571,200	233	761,600
CY-325.../W	3-1/4	4	6	8	5.45	2.30	16	9/16	5.00	0.31	3.87	11.79	571,200	233	761,600
CY-350.../W	3-1/2	4	6	8	5.70	2.40	18	9/16	5.50	0.31	3.87	13.02	642,600	233	856,800
CY-375.../W	3-3/4	4	6	8	5.95	2.40	18	9/16	5.50	0.31	3.87	13.49	642,600	233	856,800
CY-400.../W	4	4	6	8	6.20	2.60	20	9/16	6.00	0.31	4.19	15.50	714,000	233	952,000
CY-425.../W	4-1/4	4	6	8	6.95	3.00	18	5/8	6.40	0.38	4.76	23.50	907,200	390	1,209,600
CY-450.../W	4-1/2	4	6	8	7.20	3.00	18	5/8	6.65	0.38	4.76	24.53	907,200	390	1,209,600
CY-475.../W	4-3/4	4	6	8	7.45	3.20	20	5/8	6.90	0.38	5.06	29.90	1,008,000	390	1,344,000
CY-500.../W	5	4	6	8	7.70	3.30	20	5/8	7.15	0.38	5.06	28.83	1,008,000	390	1,344,000
CY-525.../W	5-1/4	4	6	8	7.95	3.70	22	5/8	7.65	0.38	5.36	33.12	1,108,800	390	1,478,400
CY-550.../W	5-1/2	4	6	8	7.95	3.70	22	5/8	7.65	0.38	5.36	30.62	1,108,800	390	1,478,400
CY-575.../W	5-3/4	4	6	8	8.45	4.00	24	5/8	8.15	0.38	5.76	38.31	1,209,600	390	1,612,800
CY-600.../W	6	4	6	8	8.45	4.00	24	5/8	8.15	0.38	5.76	35.36	1,209,600	390	1,612,800

\* All preload and torque values are provided for general reference. Applied preload plus additional bolt load from service should not exceed the maximum bolt or stud capacity. Contact your local Nord-Lock sales office for assistance in determining proper preload and torque settings for your application.  
 - Other sizes, thread pitches or thread per inch (TPI) may be available.  
 - Dimensions listed are representative.



# SB8

## Bolt-style tensioner standard

SB8 bolt-style tensioners are most often used for applications with tapped holes. The diameter of the bolt-style tensioner head is smaller than a nut-style tensioner, so bolt-style tensioners can fit tighter spaces. They feature an external installation/removal hex.

Components:  
 1 Bolt body  
 2 Jackbolts  
 3 Hardened washer

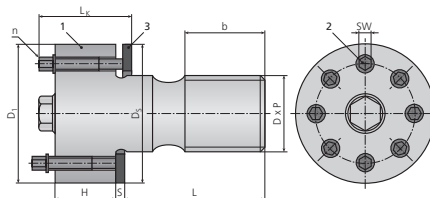

Metric	Size			Bolt body		Jackbolt		Hardened washer		Height tot L <sub>k</sub> [mm]	Preload* nom F [kN]	Torque* nom M [Nm]	Preload capacity* max [kN]	
	Thread D [mm]	Available pitch P <sub>1</sub> P <sub>2</sub> P <sub>3</sub> [mm]			D <sub>1</sub> [mm]	H [mm]	n	2 SW [mm]	D <sub>s</sub> [mm]					3 S [mm]
SB8-M16x...x.../W	M16	2	1.5	1	31	18	4	5	30	3	32	73	14	94
SB8-M20x...x.../W	M20	2.5	1.5	1	35	18	6	5	35	4	33	109	14	140
SB8-M24x...x.../W	M24	3	2	1.5	41	18	8	5	41	4	33	146	14	187
SB8-M27x...x.../W	M27	3	2	1.5	45	23	6	6	45	5	45	190	32	250
SB8-M30x...x.../W	M30	3.5	2	1.5	50	23	6	6	50	5	45	214	36	286
SB8-M33x...x.../W	M33	3.5	2	1.5	57	28	6	8	57	5	52	285	60	380
SB8-M36x...x.../W	M36	4	3	1.5	60	28	6	8	60	5	52	333	70	443
SB8-M39x...x.../W	M39	4	3	1.5	63	28	8	8	63	5	52	406	64	540
SB8-M42x...x.../W	M42	4.5	3	1.5	66	28	8	8	66	5	52	457	72	610
SB8-M45x...x.../W	M45	4.5	3	1.5	75	37	8	10	75	6	64	535	100	720
SB8-M48x...x.../W	M48	5	3	1.5	78	37	8	10	78	6	64	605	113	800
SB8-M52x...x.../W	M52	5	3	2	82	37	10	10	82	6	64	735	110	970
SB8-M56x...x.../W	M56	5.5	4	2	86	37	10	10	86	6	64	835	125	1120
SB8-M60x...x.../W	M60	5.5	4	2	90	37	12	10	90	6	64	985	123	1310
SB8-M64x...x.../W	M64	6	4	2	103	46	8	14	103	8	83	950	235	1270
SB8-M68x...x.../W	M68	6	4	2	107	46	8	14	107	8	83	1090	270	1450
SB8-M72x...x.../W	M72	6	4	2	111	46	10	14	111	8	83	1230	245	1640
SB8-M76x...x.../W	M76	6	4	2	116	46	12	14	116	8	83	1390	230	1870
SB8-M80x...x.../W	M80	6	4	2	120	56	12	14	120	8	92	1570	260	2080
SB8-M90x...x.../W	M90	6	4	2	130	56	16	14	130	8	92	2010	250	2700
SB8-M100x...x.../W	M100	6	4	2	148	60	12	17	148	10	99	2540	520	3370
SB8-M110x...x.../W	M110	6	4	2	158	60	14	17	158	10	99	2850	500	3750
SB8-M120x...x.../W	M120	6	4	2	170	64	16	17	170	10	105	3380	520	4500
SB8-M125x...x.../W	M125	6	4	2	175	64	16	17	175	10	105	3650	560	4880
SB8-M130x...x.../W	M130	6	4	2	180	76	18	17	180	10	118	3950	540	5270
SB8-M140x...x.../W	M140	6	4	2	190	76	20	17	190	10	118	4550	560	6100
SB8-M150x...x.../W	M150	6	4	2	200	76	20	17	200	10	118	4880	600	6500
SB8-M160x...x.../W	M160	6	4	-	210	76	20	17	210	10	118	5280	650	7000

Imperial	Size			Bolt body		Jackbolt		Hardened washer		Height tot L <sub>k</sub> [in]	Preload* nom F [Lbf]	Torque* nom M [Lbft]	Preload capacity* max [Lbf]	
	Thread D [in]	Available TPI P <sub>1</sub> P <sub>2</sub> P <sub>3</sub>			D <sub>1</sub> [in]	H [in]	n	2 SW [in]	D <sub>s</sub> [in]					3 S [in]
SB8-075...x.../W	3/4	10	16	-	1.35	0.70	4	3/16	1.35	0.13	1.38	20,400	14	27,100
SB8-087...x.../W	7/8	9	14	-	1.48	0.70	6	3/16	1.48	0.13	1.38	30,600	14	40,700
SB8-100...x.../W	1	8	12	14	1.59	0.70	8	3/16	1.59	0.13	1.38	40,800	14	54,200
SB8-112...x.../W	1-1/8	7	8	12	1.83	0.90	6	1/4	1.83	0.16	1.68	48,600	27	63,600
SB8-125...x.../W	1-1/4	7	8	12	1.98	0.90	8	1/4	1.98	0.16	1.68	64,800	27	86,100
SB8-137...x.../W	1-3/8	6	8	12	2.23	1.10	6	5/16	2.23	0.20	2.03	73,800	49	98,100
SB8-150...x.../W	1-1/2	6	8	12	2.35	1.10	8	5/16	2.35	0.20	2.03	88,500	44	117,700
SB8-162...x.../W	1-5/8	6	8	12	2.47	1.10	10	5/16	2.47	0.20	2.03	106,100	42	141,100
SB8-175...x.../W	1-3/4	5	8	12	2.73	1.40	8	3/8	2.73	0.25	2.49	119,200	69	158,500
SB8-187...x.../W	1-7/8	6	8	12	2.98	1.45	8	7/16	2.98	0.25	2.60	145,900	95	194,000
SB8-200...x.../W	2	4.5	8	12	3.20	1.45	8	7/16	3.20	0.25	2.60	157,300	102	209,200
SB8-225...x.../W	2-1/4	4.5	8	12	3.45	1.45	10	7/16	3.45	0.25	2.60	207,100	108	275,400
SB8-250...x.../W	2-1/2	4	8	12	3.94	1.80	8	9/16	3.94	0.31	3.26	220,200	180	292,800
SB8-275...x.../W	2-3/4	4	8	12	4.20	1.80	10	9/16	4.20	0.31	3.26	272,600	178	362,500
SB8-300...x.../W	3	4	6	8	4.47	1.80	12	9/16	4.45	0.31	3.26	333,700	182	443,800
SB8-325...x.../W	3-1/4	4	6	8	4.70	2.20	14	9/16	4.70	0.31	3.61	403,000	188	535,900
SB8-350...x.../W	3-1/2	4	6	8	4.95	2.20	16	9/16	4.95	0.31	3.61	479,500	196	637,700
SB8-375...x.../W	3-3/4	4	6	8	5.44	2.35	14	5/8	5.44	0.38	4.01	545,700	302	725,700
SB8-400...x.../W	4	4	6	8	5.70	2.35	16	5/8	5.70	0.38	4.01	630,900	305	839,000
SB8-425...x.../W	4-1/4	4	6	8	5.94	2.35	16	5/8	5.94	0.38	4.01	741,800	359	986,500
SB8-450...x.../W	4-1/2	4	6	8	6.22	2.35	18	5/8	6.22	0.38	4.01	839,600	361	1,116,600
SB8-475...x.../W	4-3/4	4	6	8	6.44	3.00	18	5/8	6.44	0.38	4.76	907,200	390	1,206,500
SB8-500...x.../W	5	4	6	8	6.70	3.00	20	5/8	6.70	0.38	4.76	1,008,000	390	1,340,600
SB8-525...x.../W	5-1/4	4	6	8	6.94	3.00	20	5/8	6.94	0.38	4.76	1,008,000	390	1,340,600
SB8-550...x.../W	5-1/2	4	6	8	7.20	3.00	20	5/8	7.20	0.38	4.76	1,008,000	390	1,340,600
SB8-575...x.../W	5-3/4	4	6	8	7.44	3.00	20	5/8	7.44	0.38	4.76	1,008,000	390	1,340,600
SB8-600...x.../W	6	4	6	8	7.69	3.00	20	5/8	7.69	0.38	4.76	1,008,000	390	1,340,600

\* All preload and torque values are provided for general reference. Applied preload plus additional bolt load from service should not exceed the maximum bolt or stud capacity.

Contact your local Nord-Lock sales office for assistance in determining proper preload and torque settings for your application.

- Other sizes, thread pitches or thread per inch (TPI) may be available.

- Dimensions listed are representative.

# SB12

## Bolt-style tensioner high strength

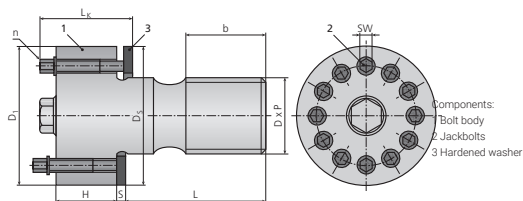

SB12 bolt-style tensioners have the same features as the SB8 bolt-style tensioners and are designed for higher strength requirements.

Metric	Size			Bolt body		Jackbolt		Hardened washer		Height tot L <sub>k</sub> [mm]	Preload* nom F [kN]	Torque* nom M [Nm]	Preload capacity* max [kN]	
	Part number	Thread D [mm]	Available pitch P <sub>1</sub> P <sub>2</sub> P <sub>3</sub> [mm]			D <sub>1</sub> [mm]	H [mm]	n	SW [mm]					D <sub>s</sub> [mm]
SB12-M20x...x.../W	M20	2.5	1.5	1	35	18	8	5	35	4	33	146	14	187
SB12-M24x...x.../W	M24	3	2	1.5	43	24	6	6	43	4	44	202	34	268
SB12-M27x...x.../W	M27	3	2	1.5	47	24	8	6	47	5	45	270	34	357
SB12-M30x...x.../W	M30	3.5	2	1.5	50	24	10	6	50	5	45	317	32	427
SB12-M33x...x.../W	M33	3.5	2	1.5	57	28	8	8	57	5	52	406	64	539
SB12-M36x...x.../W	M36	4	3	1.5	60	28	10	8	60	5	52	480	60	635
SB12-M39x...x.../W	M39	4	3	1.5	63	28	12	8	63	5	52	570	60	760
SB12-M42x...x.../W	M42	4.5	3	1.5	66	28	12	8	66	5	52	645	68	855
SB12-M45x...x.../W	M45	4.5	3	1.5	75	37	10	10	75	6	64	760	114	1020
SB12-M48x...x.../W	M48	5	3	1.5	78	37	10	10	78	6	64	855	128	1140
SB12-M52x...x.../W	M52	5	3	2	82	37	12	10	82	6	64	995	124	1320
SB12-M56x...x.../W	M56	5.5	4	2	86	37	12	10	86	6	64	995	124	1320
SB12-M60x...x.../W	M60	5.5	4	2	90	37	14	10	90	6	64	1160	124	1540
SB12-M64x...x.../W	M64	6	4	2	103	46	10	14	103	8	83	1310	260	1740
SB12-M68x...x.../W	M68	6	4	2	107	46	10	14	107	8	83	1480	295	1990
SB12-M72x...x.../W	M72	6	4	2	111	56	12	14	111	8	92	1690	280	2260
SB12-M76x...x.../W	M76	6	4	2	116	56	14	14	116	8	92	1900	270	2540
SB12-M80x...x.../W	M80	6	4	2	120	56	14	14	120	8	92	2110	300	2820
SB12-M90x...x.../W	M90	6	4	2	139	61	12	17	139	10	99	2740	560	3660

Imperial	Size			Bolt body		Jackbolt		Hardened washer		Height tot L <sub>k</sub> [in]	Preload* nom F [LBf]	Torque* nom M [LBft]	Preload capacity* max [LBf]	
	Part number	Thread D [in]	Available TPI P <sub>1</sub> P <sub>2</sub> P <sub>3</sub>			D <sub>1</sub> [in]	H [in]	n	SW [in]					D <sub>s</sub> [in]
SB12-075-...x.../W	3/4	10	16	-	1.35	0.70	6	3/16	1.35	0.13	1.38	26,200	12	34,800
SB12-087-...x.../W	7/8	9	14	-	1.48	0.70	8	3/16	1.48	0.13	1.38	36,300	13	48,200
SB12-100-...x.../W	1	8	12	14	1.73	0.90	6	1/4	1.73	0.16	1.68	47,700	27	63,400
SB12-112-...x.../W	1-1/8	7	8	12	1.85	0.90	8	1/4	1.83	0.16	1.68	60,000	25	79,800
SB12-125-...x.../W	1-1/4	7	8	12	1.98	0.90	12	1/4	1.98	0.16	1.68	77,000	21	102,400
SB12-137-...x.../W	1-3/8	6	8	12	2.23	1.10	10	5/16	2.23	0.20	2.03	90,700	36	120,600
SB12-150-...x.../W	1-1/2	6	8	12	2.35	1.10	12	5/16	2.35	0.20	2.03	100,000	33	133,000
SB12-162-...x.../W	1-5/8	6	8	12	2.47	1.10	12	5/16	2.47	0.20	2.03	120,700	40	160,500
SB12-175-...x.../W	1-3/4	5	8	12	2.73	1.40	12	3/8	2.73	0.25	2.49	131,200	51	174,400
SB12-187-...x.../W	1-7/8	6	8	12	2.98	1.50	10	7/16	2.98	0.25	2.60	167,900	88	223,300
SB12-200-...x.../W	2	4.5	8	12	3.20	1.50	12	7/16	3.20	0.25	2.60	172,100	74	228,800
SB12-225-...x.../W	2-1/4	4.5	8	12	3.45	1.60	12	7/16	3.45	0.25	2.85	239,800	104	318,900
SB12-250-...x.../W	2-1/2	4	8	12	3.95	1.80	10	9/16	3.94	0.31	3.26	280,000	183	372,400
SB12-275-...x.../W	2-3/4	4	8	12	4.20	2.20	12	9/16	4.20	0.31	3.61	348,500	189	463,500
SB12-300-...x.../W	3	4	6	8	4.45	2.20	14	9/16	4.45	0.31	3.61	424,700	197	564,800
SB12-325-...x.../W	3-1/4	4	6	8	4.95	2.35	12	5/8	4.95	0.38	4.01	508,300	328	676,000
SB12-350-...x.../W	3-1/2	4	6	8	5.20	2.35	14	5/8	5.20	0.38	4.01	599,500	332	797,300

\* All preload and torque values are provided for general reference. Applied preload plus additional bolt load from service should not exceed the maximum bolt or stud capacity. Contact your local Nord-Lock sales office for assistance in determining proper preload and torque settings for your application.  
 - Other sizes, thread pitches or thread per inch (TPI) may be available.  
 - Dimensions listed are representative.



# H650

## Nut-style tensioner Medium temperature

H650 tensioners are used for medium-temperature applications. Preload and torque values are based on a bolt stress of 310 MPa (45,000 psi), the value most commonly used by pressure-vessel designers. Depending on operating temperature, jackbolt torque and preload may be increased.

Components:  
1 Nut body  
2 Jackbolts  
3 Hardened washer

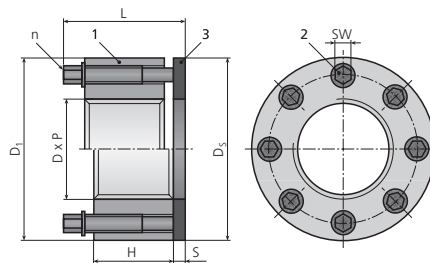

Metric	Size			Nut body		Jackbolt		Hardened washer		Height tot L [mm]	Weight est [kg]	Preload* nom F [kN]	Torque* nom M [Nm]	
	Thread D [mm]	Available pitch P <sub>1</sub> [mm] P <sub>2</sub> P <sub>3</sub>			1 D <sub>1</sub> [mm] H [mm]	2 n SW [mm]	3 D <sub>s</sub> [mm] S [mm]							
H650-M20x.../W	M20	2.5	1.5	1	38	16	6	5	38	4	34	0.14	75	10
H650-M22x.../W	M22	2.5	1.5	1	41	16	6	5	41	4	34	0.16	94	12
H650-M24x.../W	M24	3	2	1.5	44	16	8	5	43	4	34	0.19	110	11
H650-M27x.../W	M27	3	2	1.5	50	24	6	6	50	5	45	0.35	140	24
H650-M30x.../W	M30	3.5	2	1.5	53	24	6	6	53	5	45	0.37	175	30
H650-M33x.../W	M33	3.5	2	1.5	59	24	8	6	59	5	45	0.48	215	27
H650-M36x.../W	M36	4	3	1.5	66	32	6	8	66	5	57	0.76	255	53
H650-M39x.../W	M39	4	3	1.5	70	32	8	8	70	5	57	0.90	300	47
H650-M42x.../W	M42	4.5	3	1.5	75	32	8	8	73	5	57	1.01	350	55
H650-M45x.../W	M45	4.5	3	1.5	83	38	8	10	81	6	68	1.48	405	75
H650-M48x.../W	M48	5	3	1.5	85	38	8	10	85	6	68	1.50	455	85
H650-M52x.../W	M52	5	3	2	94	38	8	10	89	6	68	1.80	540	100
H650-M56x.../W	M56	5.5	4	2	100	38	8	10	95	6	68	2.00	630	120
H650-M60x.../W	M60	5.5	4	2	107	38	10	10	100	6	68	2.30	740	110
H650-M64x.../W	M64	6	4	2	113	53	8	14	112	8	92	3.65	830	205
H650-M72x.../W	M72	6	4	2	120	56	8	14	120	8	92	4.00	1070	265
H650-M76x.../W	M76	6	4	2	132	56	12	14	127	8	92	5.10	1200	200
H650-M80x.../W	M80	6	4	2	132	56	12	14	127	8	92	4.80	1330	220
H650-M90x.../W	M90	6	4	2	145	59	16	14	140	8	99	6.00	1730	215
H650-M100x.../W	M100	6	4	2	164	61	16	14	152	8	99	7.80	2170	270
H650-M110x.../W	M110	6	4	2	177	79	12	17	172	10	125	11.40	2650	550
H650-M120x.../W	M120	6	4	2	189	81	16	17	179	10	125	13.00	3210	500
H650-M125x.../W	M125	6	4	2	194	81	16	17	190	10	125	13.50	3470	540

Imperial	Size			Nut body		Jackbolts		Hardened washer		Height tot L [in]	Weight est [Lb]	Preload* nom F [Lbf]	Torque* nom M [Lbft]	
	Thread D [in]	Available TPI P <sub>1</sub> P <sub>2</sub> P <sub>3</sub>			1 D <sub>1</sub> [in] H [in]	2 n SW [in]	3 D <sub>s</sub> [in] S [in]							
H650-075-.../W	3/4	10	16	-	1.47	0.70	4	3/16	1.50	0.13	1.38	0.31	13,950	9
H650-087-.../W	7/8	9	14	-	1.60	0.70	6	3/16	1.63	0.13	1.38	0.34	19,790	9
H650-100-.../W	1	8	12	14	1.90	0.93	6	1/4	2.00	0.19	1.71	0.68	27,260	15
H650-112-.../W	1-1/8	7	8	12	2.08	0.93	6	1/4	2.13	0.19	1.71	0.79	35,570	20
H650-125-.../W	1-1/4	7	8	12	2.25	0.94	8	1/4	2.38	0.19	1.71	0.92	44,990	19
H650-137-.../W	1-3/8	6	8	12	2.46	1.20	6	5/16	2.50	0.19	2.12	1.40	55,510	37
H650-150-.../W	1-1/2	6	8	12	2.70	1.20	8	5/16	2.75	0.19	2.12	1.70	67,130	33
H650-162-.../W	1-5/8	6	8	12	2.96	1.20	8	5/16	2.88	0.19	2.12	2.01	79,860	40
H650-175-.../W	1-3/4	5	8	12	3.08	1.42	8	3/8	3.13	0.25	2.49	2.53	93,700	54
H650-187-.../W	1-7/8	6	8	12	3.59	1.60	8	7/16	3.50	0.25	2.85	4.07	108,600	71
H650-200-.../W	2	4.5	8	12	3.59	1.60	8	7/16	3.50	0.25	2.85	3.87	124,700	81
H650-225-.../W	2-1/4	4.5	8	12	3.95	1.60	8	7/16	3.75	0.25	2.85	4.51	160,100	104
H650-250-.../W	2-1/2	4	8	12	4.45	2.10	8	9/16	4.50	0.31	3.61	7.82	199,900	163
H650-275-.../W	2-3/4	4	8	12	4.70	2.10	8	9/16	4.75	0.31	3.61	8.36	244,100	199
H650-300-.../W	3	4	6	8	5.20	2.10	12	9/16	5.00	0.31	3.61	10.30	292,800	159
H650-325-.../W	3-1/4	4	6	8	5.45	2.20	12	9/16	5.00	0.31	3.61	11.04	345,900	188
H650-350-.../W	3-1/2	4	6	8	5.70	2.30	16	9/16	5.50	0.31	3.87	12.62	403,300	164
H650-375-.../W	3-3/4	4	6	8	6.20	2.40	16	9/16	5.50	0.31	3.87	15.08	465,300	189
H650-400-.../W	4	4	6	8	6.45	2.60	18	9/16	6.00	0.31	4.19	17.31	531,600	192
H650-425-.../W	4-1/4	4	6	8	6.95	3.00	16	5/8	6.40	0.38	4.76	23.41	602,300	291
H650-450-.../W	4-1/2	4	6	8	7.20	3.00	16	5/8	6.65	0.38	4.76	24.44	677,500	328
H650-475-.../W	4-3/4	4	6	8	7.45	3.20	18	5/8	6.90	0.38	5.06	27.13	757,100	326
H650-500-.../W	5	4	6	8	7.70	3.30	20	5/8	7.15	0.38	5.06	28.83	841,100	325

\* All preload and torque values are provided for general reference. Applied preload plus additional bolt load from service should not exceed the maximum bolt or stud capacity. Contact your local Nord-Lock sales office for assistance in determining proper preload and torque settings for your application.  
- Other sizes, thread pitches or thread per inch (TPI) may be available.  
- Dimensions listed are representative.

# H650T

## Nut-style tensioner

### Medium temperature, tall

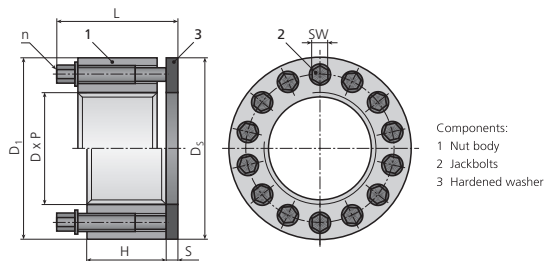

H650T tensioners are intended for use where space is limited, and typically replace acorn and castle nuts. Preload and torque values are based on a bolt stress of 310 MPa (45,000 psi).

Metric	Size				Nut body		Jackbolt		Hardened washer		Height	Weight	Preload*	Torque*
	Thread	Available pitch			1		2		3					
Part number	D [mm]	P <sub>1</sub> [mm]	P <sub>2</sub>	P <sub>3</sub>	D <sub>1</sub> [mm]	H [mm]	n	SW [mm]	D <sub>s</sub> [mm]	S [mm]	tot L [mm]	est [kg]	nom F [kN]	nom M [Nm]
H650T-M24x.../W	M24	3	2	1.5	41	28	8	5	40	3	43	0.20	110	11
H650T-M27x.../W	M27	3	2	1.5	43	28	10	5	43	3	43	0.25	140	11
H650T-M30x.../W	M30	3.5	2	1.5	46	28	12	5	46	3	43	0.25	175	11
H650T-M33x.../W	M33	3.5	2	1.5	49	28	14	5	49	3	43	0.30	215	12
H650T-M36x.../W	M36	4	3	1.5	53	28	16	5	53	6	46	0.35	255	12
H650T-M39x.../W	M39	4	3	1.5	61	38	10	6	61	4	57	0.60	300	30
H650T-M42x.../W	M42	4.5	3	1.5	64	38	12	6	64	4	57	0.65	350	30
H650T-M45x.../W	M45	4.5	3	1.5	67	38	14	6	67	6	59	0.75	405	29
H650T-M48x.../W	M48	5	3	1.5	72	38	14	6	70	10	63	0.90	455	33
H650T-M52x.../W	M52	5	3	2	79	46	12	8	78	5	69	1.25	540	56
H650T-M56x.../W	M56	5.5	4	2	84	46	14	8	82	10	74	1.45	630	57
H650T-M60x.../W	M60	5.5	4	2	90	46	16	8	86	14	78	1.75	740	58
H650T-M64x.../W	M64	6	4	2	96	62	12	10	96	18	102	2.75	830	105
H650T-M72x.../W	M72	6	4	2	106	62	16	10	105	6	90	2.80	1070	100
H650T-M76x.../W	M76	6	4	2	114	62	16	10	112	12	96	3.50	1200	110
H650T-M80x.../W	M80	6	4	2	118	62	18	10	112	15	99	3.70	1330	110
H650T-M90x.../W	M90	6	4	2	135	80	14	14	135	9	117	6.10	1730	245
H650T-M100x.../W	M100	6	4	2	149	80	16	14	144	19	127	7.85	2170	270

Imperial	Size				Nut body		Jackbolt		Hardened washer		Height	Weight	Preload*	Torque*
	Thread	Available TPI			1		2		3					
Part number	D [in]	P <sub>1</sub>	P <sub>2</sub>	P <sub>3</sub>	D <sub>1</sub> [in]	H [in]	n	SW [in]	D <sub>s</sub> [in]	S [in]	tot L [in]	est [Lb]	nom F [Lbf]	nom M [Lbft]
H650T-100-.../W	1	8	12	14	1.67	1.10	8	3/16	1.67	0.13	1.72	0.53	27,260	9
H650T-112-.../W	1-1/8	7	8	12	1.80	1.10	8	3/16	1.75	0.13	1.72	0.58	35,570	12
H650T-125-.../W	1-1/4	7	8	12	1.92	1.10	12	3/16	1.88	0.13	1.72	0.64	44,990	10
H650T-137-.../W	1-3/8	6	8	12	2.08	1.10	14	3/16	2.05	0.25	1.84	0.80	55,510	11
H650T-150-.../W	1-1/2	6	8	12	2.34	1.50	10	1/4	2.29	0.15	2.24	1.17	67,130	22
H650T-162-.../W	1-5/8	6	8	12	2.47	1.50	12	1/4	2.47	0.15	2.24	1.26	79,860	22
H650T-175-.../W	1-3/4	5	8	12	2.62	1.50	14	1/4	2.60	0.25	2.34	1.46	93,700	22
H650T-187-.../W	1-7/8	6	8	12	2.79	1.50	16	1/4	2.75	0.38	2.47	1.75	108,600	22
H650T-200-.../W	2	4.5	8	12	3.06	1.80	12	5/16	3.00	0.20	2.73	2.45	124,700	41
H650T-225-.../W	2-1/4	4.5	8	12	3.37	1.80	16	5/16	3.26	0.40	2.93	3.12	160,100	40
H650T-250-.../W	2-1/2	4	8	12	3.75	2.10	16	3/8	3.68	0.40	3.29	4.38	199,900	58
H650T-275-.../W	2-3/4	4	8	12	4.13	2.50	14	7/16	4.12	0.25	3.65	5.92	244,100	91
H650T-300-.../W	3	4	6	8	4.49	2.50	16	7/16	4.40	0.50	3.90	7.50	292,800	95
H650T-325-.../W	3-1/4	4	6	8	4.87	2.50	18	7/16	4.65	0.70	4.10	9.21	345,900	100
H650T-350-.../W	3-1/2	4	6	8	5.30	3.15	14	9/16	5.19	0.35	4.60	12.69	403,300	188
H650T-375-.../W	3-3/4	4	6	8	5.62	3.15	16	9/16	5.60	0.60	4.85	15.11	465,300	189
H650T-400-.../W	4	4	6	8	5.97	3.15	18	9/16	5.69	0.80	5.05	17.26	531,600	192

\* All preload and torque values are provided for general reference. Applied preload plus additional bolt load from service should not exceed the maximum bolt or stud capacity. Contact your local Nord-Lock sales office for assistance in determining proper preload and torque settings for your application.  
 - Other sizes, thread pitches or thread per inch (TPI) may be available.  
 - Dimensions listed are representative.





## Get design flexibility during installation

Our design capabilities and quick service give you unequalled flexibility, for trouble-free installation.

# REACTIVE SIDE SOLUTIONS

**Superbolt developed the Flexnut for through-hole applications. Flexnuts bring the advantages of MJT-type elasticity to the reactive side of the joint.**

Flexnuts are designed to flex out at the bottom and flex in toward the top of the nut. This distributes the bolt load along many threads, adds elasticity, and prevents stress concentrations in the first few threads.

INSTALLATION TIP: Flexnuts are reactive nuts, designed to be applied opposite Superbolt tensioners. They are never torqued directly to achieve preload.





# SX8

## Flexnut series

### standard

SX8 series Flexnuts are designed to flex within the common bolt-stress range for most Superbolt tensioners. They are ideal for reducing stress concentrations in the threads, and for adding flexibility to joints. SX8 series Flexnuts are suited for use with SB8 bolt-style tensioners or in conjunction with through-studs and MT nut-style tensioners.

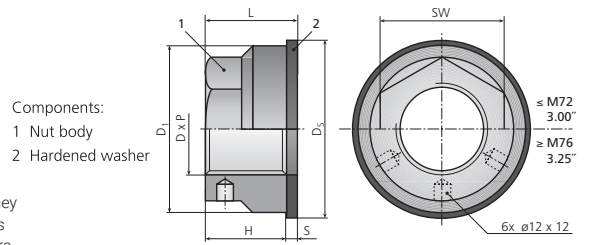

Metric	Size			Nut body			Hardened washer		Height	Weight	Preload capacity	
	Thread	Available pitch			1			2		tot		est
Part number	D	P <sub>1</sub>	P <sub>2</sub>	P <sub>3</sub>	D <sub>1</sub>	H	SW	D <sub>s</sub>	S	L	[kg]	[kN]
SX8-M20x.../W	M20	2.5	1.5	1	35	17	27	38	4	21	0.10	140
SX8-M24x.../W	M24	3	2	1.5	42	20	33	45	4	24	0.15	187
SX8-M27x.../W	M27	3	2	1.5	47	23	36	50	5	28	0.20	285
SX8-M30x.../W	M30	3.5	2	1.5	52	25	39	56	5	30	0.25	286
SX8-M33x.../W	M33	3.5	2	1.5	57	28	42	63	6	34	0.40	380
SX8-M36x.../W	M36	4	3	1.5	62	31	48	69	6	37	0.50	460
SX8-M39x.../W	M39	4	3	1.5	66	33	51	72	6	39	0.60	610
SX8-M42x.../W	M42	4.5	3	1.5	73	36	56	76	6	42	0.75	610
SX8-M45x.../W	M45	4.5	3	1.5	77	38	57	81	6	44	0.85	935
SX8-M48x.../W	M48	5	3	1.5	83	41	64	86	6	47	1.10	935
SX8-M52x.../W	M52	5	3	2	88	44	67	94	6	50	1.25	970
SX8-M56x.../W	M56	5.5	4	2	97	48	72	100	6	54	1.60	1120
SX8-M60x.../W	M60	5.5	4	2	105	51	76	110	8	59	2.05	1310
SX8-M64x.../W	M64	6	4	2	111	54	80	120	8	62	2.35	1690
SX8-M72x.../W	M72	6	4	2	125	61	90	130	8	69	3.15	1690
SX8-M76x.../W	M76	6	4	2	132	64	—*	138	10	74	4.20	2530
SX8-M80x.../W	M80	6	4	2	139	68	—*	145	10	78	5.20	2530
SX8-M90x.../W	M90	6	4	2	156	76	—*	160	10	86	7.10	3380
SX8-M100x.../W	M100	6	4	2	173	85	—*	180	10	95	9.00	3380
SX8-M110x.../W	M110	6	4	2	191	94	—*	202	10	104	13.00	4200
SX8-M120x.../W	M120	6	4	2	208	102	—*	215	12	114	16.75	5600
SX8-M125x.../W	M125	6	4	2	218	108	—*	227	12	120	19.50	5600
SX8-M130x.../W	M130	6	4	2	226	111	—*	234	12	123	21.25	6300
SX8-M140x.../W	M140	6	4	2	243	119	—*	253	12	131	26.25	7000
SX8-M150x.../W	M150	6	4	2	260	127	—*	271	12	139	31.75	7000
SX8-M160x.../W	M160	6	4	-	278	136	—*	290	12	148	38.75	8400

Imperial	Size			Nut body			Hardened washer		Height	Weight	Preload capacity	
	Thread	Available TPI			1			2		tot		est
Part number	D	P <sub>1</sub>	P <sub>2</sub>	P <sub>3</sub>	D <sub>1</sub>	H	SW	D <sub>s</sub>	S	L	[Lb]	[LBf]
SX8-075.../W	3/4	10	16	-	1.30	0.64	1	1.50	0.13	0.77	0.17	27,200
SX8-087.../W	7/8	9	14	-	1.52	0.74	1-1/8	1.62	0.13	0.87	0.23	40,800
SX8-100.../W	1	8	12	14	1.73	0.85	1-5/16	2.00	0.16	1.01	0.38	64,800
SX8-112.../W	1-1/8	7	8	12	1.95	0.96	1-1/2	2.12	0.16	1.12	0.52	64,800
SX8-125.../W	1-1/4	7	8	12	2.17	1.06	1-5/8	2.50	0.19	1.25	0.73	86,400
SX8-137.../W	1-3/8	6	8	12	2.38	1.17	1-3/4	2.50	0.19	1.36	0.87	98,400
SX8-150.../W	1-1/2	6	8	12	2.60	1.28	2	3.00	0.25	1.53	1.33	131,200
SX8-162.../W	1-5/8	6	8	12	2.81	1.38	2-1/8	3.00	0.25	1.63	1.54	141,100
SX8-175.../W	1-3/4	5	8	12	3.03	1.49	2-1/4	3.25	0.25	1.74	1.85	172,800
SX8-187.../W	1-7/8	6	8	12	3.25	1.59	2-1/2	3.50	0.25	1.84	2.54	233,600
SX8-200.../W	2	4.5	8	12	3.46	1.70	2-5/8	3.75	0.25	1.95	2.76	233,600
SX8-225.../W	2-1/4	4.5	8	12	3.90	1.91	3	4.22	0.31	2.22	4.07	275,400
SX8-250.../W	2-1/2	4	8	12	4.33	2.13	3-1/4	4.70	0.31	2.44	5.31	380,800
SX8-275.../W	2-3/4	4	8	12	4.76	2.34	3-5/8	4.95	0.31	2.65	7.46	380,800
SX8-300.../W	3	4	6	8	5.23	2.55	4	5.45	0.38	2.93	9.18	571,200
SX8-325.../W	3-1/4	4	6	8	5.63	2.76	—*	5.95	0.38	3.14	12.08	571,200
SX8-350.../W	3-1/2	4	6	8	6.06	2.98	—*	6.45	0.38	3.36	14.98	761,600
SX8-375.../W	3-3/4	4	6	8	6.50	3.19	—*	6.94	0.38	3.57	18.36	761,600
SX8-400.../W	4	4	6	8	6.93	3.40	—*	7.45	0.43	3.83	22.55	856,800
SX8-425.../W	4-1/4	4	6	8	7.36	3.61	—*	7.95	0.43	4.04	28.55	1,075,200
SX8-450.../W	4-1/2	4	6	8	7.79	3.83	—*	8.20	0.43	4.26	30.98	1,116,600
SX8-475.../W	4-3/4	4	6	8	8.23	4.04	—*	8.70	0.43	4.47	38.95	1,209,600
SX8-500.../W	5	4	6	8	8.66	4.25	—*	9.45	0.50	4.75	46.80	1,344,000
SX8-525.../W	5-1/4	4	6	8	9.09	4.46	—*	9.45	0.50	4.96	52.48	1,478,400
SX8-550.../W	5-1/2	4	6	8	9.53	4.68	—*	9.95	0.50	5.18	56.03	1,478,400
SX8-575.../W	5-3/4	4	6	8	9.96	4.89	—*	10.45	0.50	5.39	65.49	1,612,800
SX8-600.../W	6	4	6	8	10.39	5.10	—*	10.95	0.50	5.60	72.84	1,612,800

- Other sizes, thread pitches or thread per inch (TPI) may be available.  
 - Dimensions listed are representative.  
 \* Indicates a round shape instead of hex shape of the nut.

# SX12

## Flexnut series

### high strength

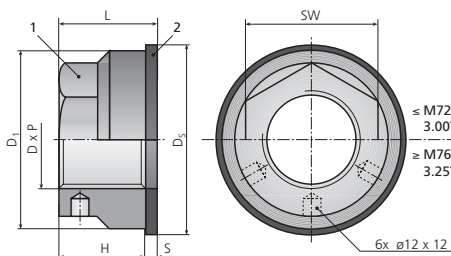

- Components:  
 1 Nut body  
 2 Hardened washer

SX12 series Flexnuts are designed for use with SB12 bolt-style tensioners, or in conjunction with through-stud and CY nut-style tensioners.

Metric	Size			Nut body			Hardened washer		Height tot	Weight est	Preload capacity max	
	Thread	Available pitch			1			2				
Part number	D [mm]	P <sub>1</sub> [mm]	P <sub>2</sub>	P <sub>3</sub>	D <sub>1</sub> [mm]	H [mm]	SW	D <sub>s</sub> [mm]	S [mm]	L [mm]	[kg]	[kN]
SX12-M20x.../W	M20	2.5	1.5	1	35	20	27	38	4	24	0.10	187
SX12-M24x.../W	M24	3	2	1.5	42	24	33	45	4	28	0.20	285
SX12-M27x.../W	M27	3	2	1.5	47	27	36	50	5	32	0.25	380
SX12-M30x.../W	M30	3.5	2	1.5	52	30	39	56	5	35	0.35	427
SX12-M33x.../W	M33	3.5	2	1.5	57	33	42	63	6	39	0.45	610
SX12-M36x.../W	M36	4	3	1.5	62	36	48	69	6	42	0.60	675
SX12-M39x.../W	M39	4	3	1.5	66	39	51	72	6	45	0.70	760
SX12-M42x.../W	M42	4.5	3	1.5	73	42	56	76	6	48	0.90	915
SX12-M45x.../W	M45	4.5	3	1.5	77	45	57	81	6	51	1.00	1170
SX12-M48x.../W	M48	5	3	1.5	83	48	64	86	6	54	1.30	1170
SX12-M52x.../W	M52	5	3	2	88	52	67	94	6	58	1.50	1400
SX12-M56x.../W	M56	5.5	4	2	97	56	72	100	6	62	1.95	1400
SX12-M60x.../W	M60	5.5	4	2	105	60	76	106	8	68	2.45	2100
SX12-M64x.../W	M64	6	4	2	111	64	80	120	8	72	2.85	2100
SX12-M72x.../W	M72	6	4	2	125	72	90	130	8	80	3.90	2530
SX12-M76x.../W	M76	6	4	2	132	76	—*	138	10	86	5.05	3380
SX12-M80x.../W	M80	6	4	2	139	80	—*	145	10	90	6.15	3380
SX12-M90x.../W	M90	6	4	2	156	90	—*	160	10	100	8.50	4200
SX12-M100x.../W	M100	6	4	2	173	100	—*	180	10	110	12.50	4900
SX12-M110x.../W	M110	6	4	2	191	110	—*	202	10	120	15.50	5600
SX12-M120x.../W	M120	6	4	2	208	120	—*	215	12	132	20.00	6300
SX12-M125x.../W	M125	6	4	2	218	125	—*	227	12	137	22.75	6300
SX12-M130x.../W	M130	6	4	2	226	111	—*	234	12	123	21.25	7000
SX12-M140x.../W	M140	6	4	2	243	119	—*	253	12	131	26.25	7700
SX12-M150x.../W	M150	6	4	2	260	127	—*	271	12	139	31.75	7700
SX12-M160x.../W	M160	6	4	-	278	136	—*	290	12	148	38.75	8400

Imperial	Size			Nut body			Hardened washer		Height tot	Weight est	Preload capacity max	
	Thread	Available TPI			1			2				
Part number	D [in]	P <sub>1</sub>	P <sub>2</sub>	P <sub>3</sub>	D <sub>1</sub> [in]	H [in]	SW	D <sub>s</sub> [in]	S [in]	L [in]	[Lb]	[LBf]
SX12-075-.../W	3/4	10	16	-	1.30	0.75	1	1.50	0.13	0.88	0.15	40,800
SX12-087-.../W	7/8	9	14	-	1.52	0.88	1-1/8	1.62	0.13	1.01	0.29	54,400
SX12-100-.../W	1	8	12	14	1.73	1.00	1-5/16	2.00	0.16	1.16	0.47	64,800
SX12-112-.../W	1-1/8	7	8	12	1.95	1.13	1-1/2	2.12	0.16	1.29	0.64	86,400
SX12-125-.../W	1-1/4	7	8	12	2.17	1.25	1-5/8	2.50	0.19	1.44	0.90	102,410
SX12-137-.../W	1-3/8	6	8	12	2.38	1.38	1-3/4	2.50	0.19	1.57	1.08	131,200
SX12-150-.../W	1-1/2	6	8	12	2.60	1.50	2	3.00	0.25	1.75	1.59	172,800
SX12-162-.../W	1-5/8	6	8	12	2.81	1.63	2-1/8	3.00	0.25	1.88	1.90	172,800
SX12-175-.../W	1-3/4	5	8	12	3.03	1.75	2-1/4	3.25	0.25	2.00	2.28	259,200
SX12-187-.../W	1-7/8	6	8	12	3.25	1.88	2-1/2	3.50	0.25	2.13	2.91	233,600
SX12-200-.../W	2	4.5	8	12	3.46	2.00	2-5/8	3.75	0.25	2.25	3.43	350,400
SX12-225-.../W	2-1/4	4.5	8	12	3.90	2.25	3	4.22	0.31	2.56	5.01	350,400
SX12-250-.../W	2-1/2	4	8	12	4.33	2.50	3-1/4	4.70	0.31	2.81	6.51	571,200
SX12-275-.../W	2-3/4	4	8	12	4.76	2.75	3-5/8	4.95	0.31	3.06	8.42	571,200
SX12-300-.../W	3	4	6	8	5.20	3.00	4	5.45	0.38	3.38	11.33	761,600
SX12-325-.../W	3-1/4	4	6	8	5.63	3.25	—*	5.94	0.38	3.63	14.93	761,600
SX12-350-.../W	3-1/2	4	6	8	6.06	3.50	—*	6.45	0.38	3.88	18.27	856,800
SX12-375-.../W	3-3/4	4	6	8	6.50	3.75	—*	6.95	0.38	4.13	22.61	856,800
SX12-400-.../W	4	4	6	8	6.93	4.00	—*	7.45	0.43	4.43	27.65	952,000
SX12-425-.../W	4-1/4	4	6	8	7.36	4.25	—*	7.95	0.43	4.68	32.97	1,209,600
SX12-450-.../W	4-1/2	4	6	8	7.79	4.50	—*	8.20	0.43	4.93	38.42	1,209,600
SX12-475-.../W	4-3/4	4	6	8	8.23	4.75	—*	8.70	0.43	5.18	45.09	1,344,000
SX12-500-.../W	5	4	6	8	8.66	5.00	—*	9.45	0.50	5.50	53.75	1,344,000
SX12-525-.../W	5-1/4	4	6	8	9.09	5.25	—*	9.45	0.50	5.75	60.81	1,478,400
SX12-550-.../W	5-1/2	4	6	8	9.53	5.50	—*	9.95	0.50	6.00	69.67	1,478,400
SX12-575-.../W	5-3/4	4	6	8	9.96	5.75	—*	10.45	0.50	6.25	79.37	1,612,800
SX12-600-.../W	6	4	6	8	10.39	6.00	—*	10.95	0.50	6.50	89.75	1,612,800

- Other sizes, thread pitches or thread per inch (TPI) may be available.

- Dimensions listed are representative.

\* Indicates a round shape instead of hex shape of the nut.





## You're never limited with Superbolt technology.

Over the decades, Superbolt and the Nord-Lock Group have solved millions of bolting challenges across a multitude of industries. We work closely with customers all over the world to ensure safety and reliability on the job.



## COMMON APPLICATIONS

- Hydraulic cylinders •
- Pipe flanges •
- Shaft mounts •
- Gearboxes •
- Machine tools •
- Presses •
- Pinion stands •
- Bearings •
- Mill motors •
- Brake wheels •

# COMPACT/LOW-PROFILE TENSIONERS

**Height restrictions in applications make it difficult to preload joints adequately. That's why Superbolt developed our range of low-profile tensioners, bringing all the advantages of a traditional MJT in a compact design.**

The SJ and SJX series can be used in general applications where height is a concern.

SSJX bolt-style tensioners are designed to fit inside the same low-profile counterbore as standard socket-head cap screws.

The NM and NI series are designed as direct replacements for many standard series bearing locknuts and include a locking side-screw to secure tensioners to shafts.

The SMX series are designed as a direct replacement for mill motor armature nuts.





# SJ

## Jamnut tensioner standard low-profile

SJ jamnuts are used for applications involving limited headroom or limited thread engagement.

Components:  
1 Nut body  
2 Jackbolts  
3 Hardened washer

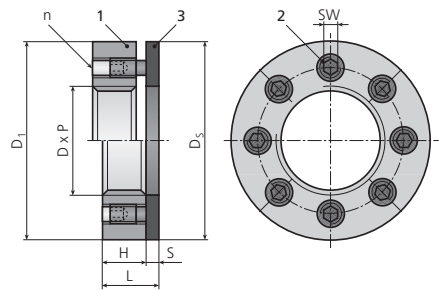

Metric	Size			Nut body		Jackbolt		Hardened washer		Height tot L [mm]	Weight est [kg]	Preload* nom F [kN]	Torque* nom M [Nm]	Preload capacity* max [kN]	
	Part number	Thread D [mm]	Available pitch P <sub>1</sub> P <sub>2</sub> P <sub>3</sub>			D <sub>1</sub> [mm]	H [mm]	n	SW [mm]						D <sub>2</sub> [mm]
SJ-M20x.../W	M20	2.5	1.5	1	43	15	6	4	43	4	19	0.15	67	11	91
SJ-M22x.../W	M22	2.5	1.5	1	47	16	8	4	45	5	21	0.20	81	10	105
SJ-M24x.../W	M24	3	2	1.5	50	16	8	4	48	5	21	0.20	89	11	120
SJ-M27x.../W	M27	3	2	1.5	53	16	10	4	50	5	21	0.25	100	10	130
SJ-M30x.../W	M30	3.5	2	1.5	60	21	8	5	59	5	26	0.40	135	21	180
SJ-M33x.../W	M33	3.5	2	1.5	63	22	10	5	63	5	27	0.40	155	19	200
SJ-M36x.../W	M36	4	3	1.5	69	28	8	6	69	5	33	0.65	190	35	245
SJ-M39x.../W	M39	4	3	1.5	75	28	10	6	75	5	33	0.80	255	38	335
SJ-M42x.../W	M42	4.5	3	1.5	81	28	12	6	78	5	33	0.90	315	39	420
SJ-M45x.../W	M45	4.5	3	1.5	88	28	12	6	81	6	34	1.00	315	39	420
SJ-M48x.../W	M48	5	3	1.5	101	31	8	8	94	6	37	1.65	380	94	500
SJ-M52x.../W	M52	5	3	2	101	33	8	8	94	6	39	1.65	380	94	500
SJ-M56x.../W	M56	5.5	4	2	113	33	12	8	100	6	39	2.05	570	94	760
SJ-M60x.../W	M60	5.5	4	2	117	33	12	8	106	6	39	2.15	570	94	760
SJ-M64x.../W	M64	6	4	2	119	33	12	8	120	8	41	2.45	570	94	760
SJ-M68x.../W	M68	6	4	2	138	38	12	10	125	8	46	3.60	710	145	950
SJ-M72x.../W	M72	6	4	2	151	38	12	10	125	8	46	4.50	910	185	1200
SJ-M76x.../W	M76	6	4	2	151	38	12	10	138	8	46	4.35	860	175	1130
SJ-M80x.../W	M80	6	4	2	158	38	12	10	145	10	48	4.95	910	185	1200
SJ-M90x.../W	M90	6	4	2	170	51	12	12	160	10	61	7.20	1160	280	1530
SJ-M100x.../W	M100	6	4	2	177	53	12	12	180	10	63	7.75	1160	280	1530
SJ-M110x.../W	M110	6	4	2	190	59	16	12	190	10	69	9.25	1550	280	2040
SJ-M120x.../W	M120	6	4	2	202	59	16	12	202	10	69	10.25	1550	280	2040
SJ-M125x.../W	M125	6	4	2	205	59	16	12	202	10	69	10.25	1550	280	2040
SJ-M130x.../W	M130	6	4	2	210	59	16	12	202	10	69	10.50	1550	280	2040
SJ-M140x.../W	M140	6	4	2	221	59	16	12	215	12	71	11.75	1550	280	2040
SJ-M150x.../W	M150	6	4	2	230	59	16	12	225	12	71	12.25	1550	280	2040
SJ-M160x.../W	M160	6	4	-	240	59	16	12	240	12	71	13.25	1550	280	2040

Imperial	Size			Nut body		Jackbolt		Hardened washer		Height tot L [in]	Weight est [Lb]	Preload* nom F [Lbf]	Torque* nom M [Lbft]	Preload capacity* max [Lbf]	
	Part number	Thread D [in]	Available TPI P <sub>1</sub> P <sub>2</sub> P <sub>3</sub>			D <sub>1</sub> [in]	H [in]	n	SW [in]						D <sub>2</sub> [in]
SJ-075.../W	3/4	10	16	-	1.70	0.55	6	5/32	1.63	0.13	0.68	0.34	16,300	9	21,700
SJ-087.../W	7/8	9	14	-	1.84	0.60	8	5/32	1.75	0.13	0.73	0.40	21,700	9	28,900
SJ-100.../W	1	8	12	14	1.95	0.60	8	5/32	2.00	0.19	0.79	0.49	21,700	9	28,900
SJ-112.../W	1-1/8	7	8	12	2.20	0.80	8	3/16	2.13	0.19	0.99	0.67	30,000	15	40,000
SJ-125.../W	1-1/4	7	8	12	2.34	0.80	8	3/16	2.38	0.19	0.99	0.85	30,000	15	40,000
SJ-137.../W	1-3/8	6	8	12	2.45	0.92	10	3/16	2.50	0.19	1.11	0.96	37,500	15	50,000
SJ-150.../W	1-1/2	6	8	12	2.95	1.10	8	1/4	2.75	0.19	1.29	1.67	56,900	37	75,900
SJ-162.../W	1-5/8	6	8	12	3.20	1.10	10	1/4	2.88	0.19	1.29	1.92	71,200	37	94,900
SJ-175.../W	1-3/4	5	8	12	3.45	1.10	12	1/4	3.45	0.25	1.35	2.33	85,400	37	113,900
SJ-187.../W	1-7/8	6	8	12	3.59	1.10	12	1/4	3.59	0.25	1.35	2.57	85,400	37	113,900
SJ-200.../W	2	4.5	8	12	3.95	1.30	8	5/16	3.50	0.25	1.55	3.63	91,400	75	121,900
SJ-225.../W	2-1/4	4.5	8	12	4.45	1.30	12	5/16	4.00	0.25	1.55	4.57	137,100	75	182,800
SJ-250.../W	2-1/2	4	8	12	4.70	1.30	12	5/16	4.50	0.31	1.61	5.25	137,100	75	182,800
SJ-275.../W	2-3/4	4	8	12	5.45	1.50	12	3/8	4.75	0.31	1.81	7.65	165,800	108	221,100
SJ-300.../W	3	4	6	8	5.95	1.90	12	1/2	5.25	0.38	2.28	12.55	226,300	179	301,700
SJ-325.../W	3-1/4	4	6	8	6.20	1.90	12	1/2	5.50	0.38	2.28	12.10	226,300	179	301,700
SJ-350.../W	3-1/2	4	6	8	6.45	1.90	12	1/2	5.75	0.38	2.28	12.72	226,300	179	301,700
SJ-375.../W	3-3/4	4	6	8	6.70	2.00	12	1/2	6.00	0.38	2.38	15.02	226,300	179	301,700
SJ-400.../W	4	4	6	8	6.95	2.00	12	1/2	6.65	0.38	2.38	15.89	226,300	179	301,700
SJ-425.../W	4-1/4	4	6	8	7.20	2.30	16	1/2	6.90	0.38	2.68	16.63	301,700	179	402,200
SJ-450.../W	4-1/2	4	6	8	7.45	2.30	16	1/2	7.40	0.38	2.68	19.07	301,700	179	402,200
SJ-475.../W	4-3/4	4	6	8	7.70	2.30	16	1/2	7.90	0.38	2.68	20.63	301,700	179	402,200
SJ-500.../W	5	4	6	8	7.95	2.30	16	1/2	7.90	0.38	2.68	21.19	301,700	179	402,200
SJ-525.../W	5-1/4	4	6	8	8.70	2.40	16	9/16	8.40	0.50	2.90	28.11	396,700	269	529,000
SJ-550.../W	5-1/2	4	6	8	8.95	2.40	16	9/16	8.40	0.50	2.90	28.75	396,700	269	529,000
SJ-575.../W	5-3/4	4	6	8	9.20	2.40	16	9/16	9.40	0.50	2.90	31.41	396,700	269	529,000
SJ-600.../W	6	4	6	8	9.45	2.40	16	9/16	9.40	0.50	2.90	31.38	396,700	269	529,000

\* All preload and torque values are provided for general reference. Applied preload plus additional bolt load from service should not exceed the maximum bolt or stud capacity. Contact your local Nord-Lock sales office for assistance in determining proper preload and torque settings for your application.

- Other sizes, thread pitches or thread per inch (TPI) may be available.

- Dimensions listed are representative.

# SJX2

## Jamnut tensioner

### high strength low-profile

SJX2 jamnuts are designed for restrictive space applications with higher preload requirements. They utilize larger, moly-lubricated set-screws to reduce torque requirements.

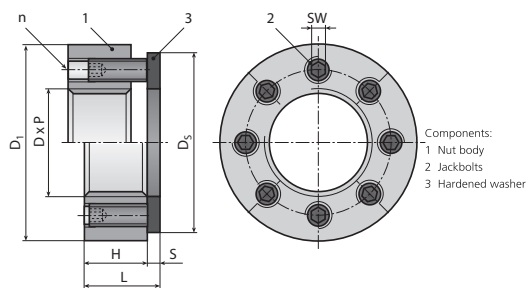

Components:  
1 Nut body  
2 Jackbolts  
3 Hardened washer

Metric	Size				Nut body		Jackbolt		Hardened washer		Height	Weight	Preload*	Torque*	Preload capacity*
	Part number	Thread D [mm]	Available pitch			D <sub>1</sub> [mm]	H [mm]	n	SW [mm]	D <sub>s</sub> [mm]					
SJX2-M20x.../W	M20	2.5	1.5	1	44	18	4	4	43	4	22	0.21	86	14	115
SJX2-M22x.../W	M22	2.5	1.5	1	47	18	4	4	45	5	23	0.24	86	14	115
SJX2-M24x.../W	M24	3	2	1.5	50	18	6	4	48	5	23	0.27	130	14	175
SJX2-M27x.../W	M27	3	2	1.5	56	18	8	4	50	5	23	0.32	170	14	215
SJX2-M30x.../W	M30	3.5	2	1.5	63	23	8	5	59	5	28	0.52	215	22	290
SJX2-M33x.../W	M33	3.5	2	1.5	69	23	10	5	63	5	28	0.61	270	22	360
SJX2-M36x.../W	M36	4	3	1.5	74	30	8	6	69	5	35	0.91	345	41	450
SJX2-M39x.../W	M39	4	3	1.5	80	30	10	6	75	5	35	1.04	405	38	530
SJX2-M42x.../W	M42	4.5	3	1.5	88	30	10	6	78	5	35	1.22	485	46	640
SJX2-M45x.../W	M45	4.5	3	1.5	90	30	10	6	81	6	36	1.33	510	48	670
SJX2-M48x.../W	M48	5	3	1.5	101	38	8	8	94	6	44	2.10	620	96	820
SJX2-M52x.../W	M52	5	3	2	107	38	10	8	106	6	44	2.37	700	87	920
SJX2-M56x.../W	M56	5.5	4	2	113	38	10	8	106	6	44	2.57	760	94	1010
SJX2-M60x.../W	M60	5.5	4	2	120	38	10	8	106	6	44	3.04	860	107	1130
SJX2-M64x.../W	M64	6	4	2	126	42	12	8	120	8	50	3.52	1110	115	1480
SJX2-M68x.../W	M68	6	4	2	145	46	12	10	125	8	54	5.11	1330	186	1740
SJX2-M72x.../W	M72	6	4	2	151	46	12	10	138	8	54	5.61	1380	193	1840
SJX2-M76x.../W	M76	6	4	2	158	52	12	10	138	8	60	6.61	1900	266	2510
SJX2-M80x.../W	M80	6	4	2	162	52	12	10	145	10	62	7.06	1900	266	2510
SJX2-M90x.../W	M90	6	4	2	177	64	12	12	160	10	74	9.98	2210	368	2930
SJX2-M100x.../W	M100	6	4	2	182	76	14	12	172	10	86	11.97	2730	390	3620
SJX2-M110x.../W	M110	6	4	2	202	79	16	12	190	10	89	15.16	3340	418	4470
SJX2-M120x.../W	M120	6	4	2	208	79	16	12	202	10	89	15.42	3340	418	4470
SJX2-M125x.../W	M125	6	4	2	214	79	16	12	202	10	89	16.03	3340	418	4470
SJX2-M130x.../W	M130	6	4	2	214	91	18	12	202	10	101	16.86	3760	418	5030
SJX2-M140x.../W	M140	6	4	2	221	91	18	12	215	12	103	18.60	3760	418	5030
SJX2-M150x.../W	M150	6	4	2	231	95	20	12	225	12	107	18.98	4110	411	5450
SJX2-M160x.../W	M160	6	4	-	241	95	20	12	240	12	107	21.32	4110	411	5450

Imperial	Size				Nut body		Jackbolt		Hardened washer		Height	Weight	Preload*	Torque*	Preload capacity*
	Part number	Thread D [in]	Available TPI			D <sub>1</sub> [in]	H [in]	n	SW [mm]	D <sub>s</sub> [in]					
SJX2-075-.../W	3/4	10	16	-	1.70	0.70	4	4	1.63	0.13	0.83	0.40	18,100	10	24,100
SJX2-087-.../W	7/8	9	14	-	1.84	0.70	6	4	1.75	0.13	0.83	0.50	25,100	9	33,400
SJX2-100-.../W	1	8	12	14	2.10	0.70	8	4	2.00	0.19	0.89	0.60	33,100	9	44,000
SJX2-112-.../W	1-1/8	7	8	12	2.34	0.90	6	5	2.13	0.19	1.09	0.90	43,700	19	58,100
SJX2-125-.../W	1-1/4	7	8	12	2.47	0.95	8	5	2.38	0.19	1.14	1.10	55,700	19	74,100
SJX2-137-.../W	1-3/8	6	8	12	2.72	0.95	10	5	2.50	0.19	1.14	1.30	69,300	18	92,200
SJX2-150-.../W	1-1/2	6	8	12	3.20	1.20	8	6	2.75	0.19	1.39	2.30	84,000	33	111,700
SJX2-162-.../W	1-5/8	6	8	12	3.45	1.20	10	6	2.88	0.19	1.39	2.70	100,800	31	134,100
SJX2-175-.../W	1-3/4	5	8	12	3.59	1.20	10	6	3.13	0.25	1.45	2.80	118,800	37	158,000
SJX2-187-.../W	1-7/8	6	8	12	3.72	1.30	12	6	3.50	0.25	1.55	3.20	138,000	36	183,500
SJX2-200-.../W	2	4.5	8	12	4.20	1.50	8	8	3.72	0.25	1.75	4.90	159,000	81	211,500
SJX2-225-.../W	2-1/4	4.5	8	12	4.70	1.50	10	8	4.00	0.25	1.75	6.10	205,200	84	272,900
SJX2-250-.../W	2-1/2	4	8	12	4.95	1.65	12	8	4.50	0.31	1.96	7.41	257,400	87	342,300
SJX2-275-.../W	2-3/4	4	8	12	5.70	1.80	12	10	4.75	0.31	2.11	11.00	315,600	145	419,800
SJX2-300-.../W	3	4	6	8	6.20	2.15	12	10	5.25	0.38	2.53	15.00	379,200	174	504,300
SJX2-325-.../W	3-1/4	4	6	8	6.70	2.15	12	10	5.50	0.38	2.53	17.00	449,400	206	597,700
SJX2-350-.../W	3-1/2	4	6	8	6.95	2.30	14	10	5.75	0.38	2.68	19.00	511,900	202	680,800
SJX2-375-.../W	3-3/4	4	6	8	7.20	2.50	16	10	6.00	0.38	2.88	22.00	606,600	209	806,800
SJX2-400-.../W	4	4	6	8	7.45	3.10	14	12	6.65	0.38	3.48	29.00	694,200	325	923,300
SJX2-425-.../W	4-1/4	4	6	8	7.95	3.10	16	12	6.90	0.38	3.48	33.00	787,200	323	1,047,000
SJX2-450-.../W	4-1/2	4	6	8	8.20	3.10	16	12	7.40	0.38	3.48	34.00	787,200	323	1,047,000
SJX2-475-.../W	4-3/4	4	6	8	8.45	3.25	18	12	7.90	0.38	3.63	37.00	904,500	330	1,203,000
SJX2-500-.../W	5	4	6	8	8.45	3.55	18	12	7.90	0.38	3.93	39.00	904,500	330	1,203,000
SJX2-525-.../W	5-1/4	4	6	8	8.70	3.60	18	12	8.40	0.50	4.10	41.00	904,500	330	1,203,000
SJX2-550-.../W	5-1/2	4	6	8	8.95	3.70	20	12	8.40	0.50	4.20	43.00	996,200	327	1,325,000
SJX2-575-.../W	5-3/4	4	6	8	9.45	3.75	20	12	9.40	0.50	4.25	48.00	1,010,600	332	1,344,000
SJX2-600-.../W	6	4	6	8	9.45	3.75	20	12	9.40	0.50	4.25	47.00	1,010,600	332	1,344,000

\* All preload and torque values are provided for general reference. Applied preload plus additional bolt load from service should not exceed the maximum bolt or stud capacity. Contact your local Nord-Lock sales office for assistance in determining proper preload and torque settings for your application.

- Other sizes, thread pitches or thread per inch (TPI) may be available.

- Dimensions listed are representative.



# SSJX2

## Bolt-style tensioner

### Low profile

SSJX2 bolt-style tensioners offer multi-jackbolt features that match the countersink dimensions of standard socket-head cap screws. Moly-lubricated set screws are included.

Components:  
1 Bolt body  
2 Jackbolts  
3 Hardened washer

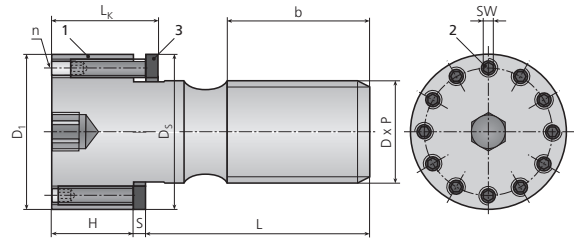

Metric	Size			Bolt body		Jackbolt		Hardened washer		Height tot L <sub>k</sub> [mm]	Preload* nom F [kN]	Torque* nom M [Nm]	Preload capacity* max [kN]	
	Part number	Thread D [mm]	Available Pitch P <sub>1</sub> [mm] P <sub>2</sub> P <sub>3</sub>			D <sub>1</sub> [mm]	H [mm]	n	SW [mm]					D <sub>s</sub> [mm]
SSJX2-M20x...x.../W	M20	2.5	1.5	1	32	17	8	3	32	4	21	94	6	125
SSJX2-M22x...x.../W	M22	3	2	1.5	35	17	10	3	35	4	21	115	6	155
SSJX2-M24x...x.../W	M24	3	2	1.5	38	19	12	3	38	4	23	140	6	185
SSJX2-M27x...x.../W	M27	3.5	2	1.5	41	19	12	3	41	5	24	140	6	185
SSJX2-M30x...x.../W	M30	3.5	2	1.5	45	23	10	4	45	5	28	215	14	290
SSJX2-M33x...x.../W	M33	4	3	1.5	50	23	12	4	50	5	28	255	14	350
SSJX2-M36x...x.../W	M36	4	3	1.5	55.5	27	10	5	55	6	33	315	25	425
SSJX2-M39x...x.../W	M39	4.5	3	1.5	59	27	12	5	59	6	33	380	26	510
SSJX2-M42x...x.../W	M42	4.5	3	1.5	63	27	12	5	63	6	33	380	26	510
SSJX2-M45x...x.../W	M45	5	3	1.5	69	38	12	6	69	6	44	530	42	710
SSJX2-M48x...x.../W	M48	5	3	2	72	38	12	6	72	6	44	600	47	790
SSJX2-M52x...x.../W	M52	5.5	4	2	76	38	12	6	76	6	44	630	50	840
SSJX2-M56x...x.../W	M56	5.5	4	2	84	38	12	6	84	6	44	630	50	840
SSJX2-M60x...x.../W	M60	6	4	2	88	38	14	6	88	6	44	740	50	980
SSJX2-M64x...x.../W	M64	6	4	2	97	51	12	8	97	8	59	930	96	1230
SSJX2-M68x...x.../W	M68	6	4	2	104	51	12	8	104	8	59	1060	109	1420
SSJX2-M72x...x.../W	M72	6	4	2	108	51	14	8	108	8	59	1200	106	1580
SSJX2-M76x...x.../W	M76	6	4	2	114	51	14	8	114	8	59	1360	120	1800
SSJX2-M80x...x.../W	M80	6	4	2	117	51	16	8	117	8	59	1490	115	1970
SSJX2-M90x...x.../W	M90	6	4	2	131	76	14	10	131	10	86	1970	236	2630
SSJX2-M100x...x.../W	M100	6	4	2	144	76	14	10	144	10	86	2210	265	2920

Imperial	Size			Bolt body		Jackbolt		Hardened washer		Height tot L <sub>k</sub> [in]	Preload* F [Lbf]	Torque* M [Lbft]	Preload capacity* max [Lbf]	
	Part number	Thread D [in]	Available TPI P <sub>1</sub> P <sub>2</sub> P <sub>3</sub>			D <sub>1</sub> [in]	H [in]	n	SW [mm]					D <sub>s</sub> [in]
SSJX2-075...x.../W	3/4	10	16	-	1.17	0.65	8	3	1.17	0.13	0.78	22,400	5	26,900
SSJX2-087...x.../W	7/8	9	14	-	1.35	0.65	10	3	1.35	0.13	0.78	28,700	5	38,300
SSJX2-100...x.../W	1	8	12	14	1.49	0.65	12	3	1.49	0.13	0.78	28,700	4	38,300
SSJX2-112...x.../W	1-1/8	7	8	12	1.70	0.90	10	4	1.70	0.16	1.06	52,700	12	63,200
SSJX2-125...x.../W	1-1/4	7	8	12	1.85	0.90	12	4	1.85	0.16	1.06	63,200	12	75,900
SSJX2-137...x.../W	1-3/8	6	8	12	2.10	1.05	10	5	2.10	0.19	1.24	75,000	20	100,000
SSJX2-150...x.../W	1-1/2	6	8	12	2.22	1.05	12	5	2.22	0.19	1.24	90,000	20	120,000
SSJX2-162...x.../W	1-5/8	6	8	12	2.43	1.05	12	5	2.43	0.19	1.24	90,000	20	120,000
SSJX2-175...x.../W	1-3/4	5	8	12	2.60	1.05	14	5	2.60	0.19	1.24	104,000	20	138,700
SSJX2-187...x.../W	1-7/8	6	8	12	2.80	1.55	12	6	2.80	0.22	1.77	142,400	37	170,900
SSJX2-200...x.../W	2	4.5	8	12	2.98	1.55	12	6	2.98	0.22	1.77	153,000	40	204,000
SSJX2-225...x.../W	2-1/4	4.5	8	12	3.40	1.55	16	6	3.40	0.22	1.77	199,300	39	239,200
SSJX2-250...x.../W	2-1/2	4	8	12	3.80	2.00	12	8	3.80	0.28	2.28	243,400	83	292,100
SSJX2-275...x.../W	2-3/4	4	8	12	4.15	2.00	14	8	4.15	0.28	2.28	283,900	83	340,700
SSJX2-300...x.../W	3	4	6	8	4.45	2.00	14	8	4.45	0.28	2.28	283,900	83	360,700
SSJX2-325...x.../W	3-1/4	4	6	8	4.90	2.50	12	10	4.90	0.28	2.78	353,300	162	424,000
SSJX2-350...x.../W	3-1/2	4	6	8	5.15	2.50	14	10	5.15	0.28	2.78	412,200	162	494,600
SSJX2-375...x.../W	3-3/4	4	6	8	5.68	3.00	12	12	5.65	0.38	3.38	490,200	268	588,200
SSJX2-400...x.../W	4	4	6	8	5.97	3.00	12	12	5.97	0.38	3.38	490,200	268	588,200

\* All preload and torque values are provided for general reference. Applied preload plus additional bolt load from service should not exceed the maximum bolt or stud capacity. Contact your local Nord-Lock sales office for assistance in determining proper preload and torque settings for your application.  
- Other sizes, thread pitches or thread per inch (TPI) may be available.  
- Dimensions listed are representative.

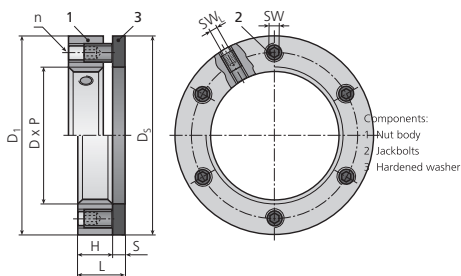

# NM2

## Bearing locknut (Metric)

Superbolt bearing locknuts are directly interchangeable with many standard locknuts. They're ideal for positioning bearings, and clamping entire shaft assemblies. NM2/NI2 bearing locknuts are designed to match correspondingly sized bearing loads.

Metric	Size		Nut body		Jackbolt			Hardened washer		Height	Weight	Preload*	Torque*	
	Part number	Thread D	Pitch P <sub>1</sub>	D <sub>1</sub>	H	1 n	2 SW	2 SW <sub>L</sub>	3 D <sub>s</sub>	3 S	tot L	est	max F	max M
	[mm]	[mm]	[mm]	[mm]		[mm]	[mm]	[mm]	[mm]	[mm]	[mm]	[kg]	[kN]	[Nm]
NM2-06/W	M30	1.5	50	10	6	3	3	50	3	13	0.14	55	5	
NM2-07/W	M35	1.5	55	10	6	3	3	55	3	13	0.18	55	5	
NM2-08/W	M40	1.5	71	12	6	4	4	71	4	16	0.36	94	11	
NM2-09/W	M45	1.5	75	12	6	4	4	75	4	16	0.41	94	11	
NM2-10/W	M50	1.5	78	12	6	4	4	78	4	16	0.41	94	11	
NM2-11/W	M55	2	84	12	6	4	4	84	4	16	0.41	94	11	
NM2-12/W	M60	2	90	12	6	4	4	90	4	16	0.50	94	11	
NM2-13/W	M65	2	94	12	6	4	4	94	4	16	0.50	94	11	
NM2-14/W	M70	2	100	12	6	4	4	100	4	16	0.54	94	11	
NM2-15/W	M75	2	104	12	6	4	4	104	4	16	0.82	94	11	
NM2-16/W	M80	2	109	18	6	5	4	109	5	23	0.82	120	16	
NM2-17/W	M85	2	114	18	6	5	4	114	5	23	0.82	120	16	
NM2-18/W	M90	2	119	18	6	5	4	119	5	23	0.91	120	16	
NM2-19/W	M95	2	126	19	8	5	4	126	5	24	1.01	160	16	
NM2-20/W	M100	2	131	19	8	5	4	131	5	24	1.09	160	16	
NM2-21/W	M105	2	138	19	8	5	4	138	5	24	1.36	200	20	
NM2-22/W	M110	2	150	22	8	6	5	150	6	28	1.81	270	32	
NM2-24/W	M120	2	159	23	8	6	5	159	6	29	1.95	270	32	
NM2-26/W	M130	2	171	24	12	6	5	171	6	30	2.36	340	27	
NM2-28/W	M140	2	182	24	12	6	5	182	6	30	2.48	340	27	
NM2-30/W	M150	2	190	25	12	6	5	190	6	31	2.68	340	27	
NM2-32/W	M160	3	213	27	8	8	6	213	8	35	4.29	425	66	

# NI2

## Bearing locknut (Imperial)

Imperial	Size		Nut body		Jackbolt			Hardened washer		Height	Weight	Preload*	Torque*	
	Part number	Thread D	TPI P <sub>1</sub>	D <sub>1</sub>	H	1 n	2 SW	2 SW <sub>L</sub>	3 D <sub>s</sub>	3 S	tot L	est	max F	max M
	[in]		[in]	[in]		[mm]	[in]	[in]	[in]	[in]	[in]	[Lb]	[LBf]	[Lbft]
NI2-06/W	1.173	18	1.95	0.39	6	3	1/8	1.95	0.19	0.58	0.30	12,750	4	
NI2-07/W	1.376	18	2.15	0.39	6	3	1/8	2.15	0.19	0.58	0.40	12,750	4	
NI2-08/W	1.563	18	2.80	0.47	6	4	5/32	2.80	0.19	0.66	0.80	20,800	8	
NI2-09/W	1.767	18	2.97	0.47	6	4	5/32	2.97	0.19	0.66	0.90	20,800	8	
NI2-10/W	1.967	18	3.09	0.47	6	4	5/32	3.09	0.19	0.66	0.90	20,800	8	
NI2-11/W	2.157	18	3.30	0.47	6	4	5/32	3.30	0.19	0.66	0.90	20,800	8	
NI2-12/W	2.360	18	3.55	0.47	6	4	5/32	3.55	0.19	0.66	1.10	20,800	8	
NI2-13/W	2.548	18	3.70	0.47	6	4	5/32	3.70	0.19	0.66	1.10	20,800	8	
NI2-14/W	2.751	18	3.95	0.47	6	4	5/32	3.95	0.19	0.66	1.20	20,800	8	
NI2-15/W	2.933	12	4.09	0.47	6	4	5/32	4.09	0.19	0.66	1.80	20,800	8	
NI2-16/W	3.137	12	4.30	0.70	6	5	5/32	4.30	0.19	0.89	1.80	36,200	16	
NI2-17/W	3.340	12	4.50	0.70	6	5	5/32	4.50	0.19	0.89	1.80	36,200	16	
NI2-18/W	3.527	12	4.70	0.70	6	5	5/32	4.70	0.19	0.89	2.00	36,200	16	
NI2-19/W	3.730	12	4.95	0.74	8	5	5/32	4.95	0.19	0.93	2.20	48,250	16	
NI2-20/W	3.918	12	5.15	0.74	8	5	5/32	5.15	0.19	0.93	2.40	48,250	16	
NI2-21/W	4.122	12	5.45	0.77	8	5	5/32	5.45	0.25	1.02	3.00	48,250	16	
NI2-22/W	4.325	12	5.90	0.85	8	6	3/16	5.90	0.25	1.10	4.00	68,000	27	
NI2-24/W	4.716	12	6.22	0.89	8	6	3/16	6.22	0.25	1.14	4.30	68,000	27	
NI2-26/W	5.106	12	6.72	0.95	12	6	3/16	6.72	0.25	1.20	5.20	92,600	24	
NI2-28/W	5.497	12	7.15	0.95	12	6	3/16	7.15	0.25	1.20	5.40	92,600	24	
NI2-30/W	5.888	12	7.47	0.97	12	6	3/16	7.47	0.25	1.22	5.90	92,600	24	
NI2-32/W	6.284	8	8.35	1.05	8	8	1/4	8.35	0.31	1.36	9.40	100,700	51	

\* All preload and torque values are provided for general reference. Applied preload plus additional bolt load from service should not exceed the maximum bolt or stud capacity. Contact your local Nord-Lock sales office for assistance in determining proper preload and torque settings for your application.  
 - Other sizes, thread pitches or thread per inch (TPI) may be available.  
 - Dimensions listed are representative.



# SMX2

## Mill motor nut

These tensioners replace the standard mill motor armature nuts supplied by motor OEMs. SMX2 tensioners are available for most standard motor frame sizes. Their preloads match the hub stress capacities of brake wheels and pulleys. For sizes not listed, including 400-series frames, contact your local Nord-Lock Group office.

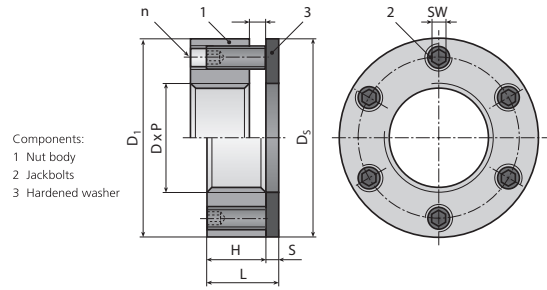

Metric	Size	Pitch	Nut body		Jackbolt		Hardened washer		Height	Weight	Preload*	Torque*
			1	H	n	2	3	S				
Part number	Thread D [mm]	P <sub>1</sub> [mm]	D <sub>1</sub> [mm]	H [mm]	n	SW [mm]	D <sub>s</sub> [mm]	S [mm]	tot L [mm]	est [kg]	max F [kN]	max M [Nm]
SMX2-45/W	M30	2	70	20	6	5	70	5	25	0.61	125	17
SMX2-50/W	M36	3	75	20	8	5	69	5	25	0.64	150	15
SMX2-55/W	M36	3	80	20	8	5	76	5	25	0.76	175	18
SMX2-60/W	M42	3	90	26	8	6	81	6	32	1.18	220	26
SMX2-65/W	M42	3	95	26	8	6	95	6	32	1.41	255	30
SMX2-70/W	M48	3	100	26	10	6	94	6	32	1.45	300	29
SMX2-75/W	M48	3	105	26	10	6	105	6	32	1.67	340	32
SMX2-80/W	M56	4	108	27	12	6	106	6	33	1.71	380	30
SMX2-85/W	M56	4	113	27	14	6	106	6	33	1.86	440	30
SMX2-90/W	M64	4	133	27	8	8	123	8	35	2.74	485	75
SMX2-95/W	M64	4	140	27	10	8	134	8	35	3.15	535	66
SMX2-100/W	M72	4	147	27	10	8	138	8	35	3.35	610	76
SMX2-110/W	M80	4	154	31	12	8	145	8	39	3.89	735	76
SMX2-120/W	M90	4	184	31	10	10	160	10	41	5.88	855	144
SMX2-130/W	M100	4	194	34	12	10	172	10	44	6.88	1030	144
SMX2-140/W	M100	4	214	34	12	10	172	10	44	8.45	1190	167
SMX2-150/W	M110	4	224	36	14	10	224	10	46	10.33	1330	160
SMX2-160/W	M125	4	224	42	16	10	202	10	52	10.33	1530	161
SMX2-170/W	M125	4	233	44	18	10	202	10	54	11.62	1720	161
SMX2-180/W	M140	6	250	44	20	10	215	10	54	13.19	1960	165
SMX2-190/W	M140	6	250	55	16	12	240	12	67	17.21	2200	275
SMX2-200/W	M160	6	265	55	18	12	240	12	67	17.31	2400	267
SMX2-220/W	M160	6	304	55	20	12	290	12	67	26.49	2900	290

Imperial	Size	TPI	Nut body		Jackbolt		Hardened washer		Height	Weight	Preload*	Torque*
			1	H	n	2	3	S				
Part number	Thread D [in]	P <sub>1</sub>	D <sub>1</sub> [in]	H [in]	n	SW [mm]	D <sub>s</sub> [in]	S [in]	tot L [in]	est [Lb]	max F [Lbf]	max M [Lbft]
SMX2-802/W	1	8	2.34	0.75	4	5	2.34	0.19	0.94	1.00	22,000	15
SMX2-803/W	1-1/4	8	2.72	0.75	6	5	2.72	0.19	0.94	1.00	33,000	15
SMX2-804/W	1-1/4	8	2.72	0.75	6	5	2.72	0.19	0.94	1.00	33,000	15
SMX2-806/W	1-1/2	8	3.59	1.00	4	6	3.59	0.25	1.25	3.00	37,000	29
SMX2-808/W	2	8	3.72	1.00	6	6	3.72	0.25	1.25	3.00	56,000	29
SMX2-810/W	2-1/4	8	4.47	1.13	4	8	4.47	0.25	1.38	5.00	66,000	67
SMX2-812/W	2-1/2	8	4.72	1.13	6	8	4.72	0.25	1.38	6.00	99,000	67
SMX2-814/W	3	8	5.47	1.25	8	8	5.47	0.25	1.50	9.00	132,000	67
SMX2-816/W	3-1/4	8	5.97	1.25	8	8	5.97	0.25	1.50	10.00	132,000	67
SMX2-818/W	3-1/2	8	6.47	1.25	8	8	6.47	0.25	1.50	12.00	132,000	67
SMX2-820/W	4	8	7.22	1.50	12	8	7.22	0.25	1.75	18.00	198,000	67
SMX2-824/W	4	8	7.72	1.50	12	8	7.72	0.25	1.75	20.00	198,000	67

\* All preload and torque values are provided for general reference. Applied preload plus additional bolt load from service should not exceed the maximum bolt or stud capacity. Contact your local Nord-Lock sales office for assistance in determining proper preload and torque settings for your application.  
 - Other sizes, thread pitches or thread per inch (TPI) may be available.  
 - Dimensions listed are representative.

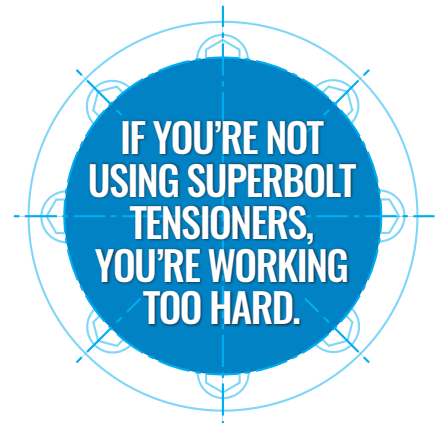



**DISCOVER THE SUPERBOLT  
SOLUTION DESIGNED FOR YOUR  
BOLTING CHALLENGES**

**STANDARD RANGE  
PRE-ENGINEERED RANGE  
CUSTOMIZED SOLUTIONS**





## Custom-designed products

When off-the-shelf parts just won't do the job, you can rely on the Superbolt Technical Center to design and manufacture exactly what you need. We respond fast to keep your downtime to a minimum and get your equipment back up and running safely, efficiently, and cost-effectively.



## COMMON APPLICATIONS

- Compressor crossheads •
- Piston-end nuts •
- Rotating equipment •
- Mining •
- Crushers •
- Gearboxes •
- Presses •
- Bearing caps •
- Coupling nuts •
- Engines •

# DYNAMIC APPLICATIONS

**Generating correct preload forces for compressors and rotating equipment can be especially demanding. Superbolt tensioners for dynamic applications incorporate an added safety design feature – captive machinery-style jackbolts.**

Gain a competitive advantage with cross-head jamnuts (CN Series) for reciprocating compressor crossheads. Simple hand tools and an easy-to-follow specific installation procedure make CN a preferred solution.

Piston-end nuts (SP Series) are specially designed to match the custom counterbore necessary dimensions of the nuts they replace.

MR Series with captive tensioners replace the traditional MT Series for rotating equipment.

The MRA Series – an armored-style tensioner with countersunk, captive jackbolts – is the solution for couplings and harsh environments.





# BOLT-INTENSIVE COMPRESSORS: THIS IS A JOB FOR SUPERBOLT.

Reciprocating compressors incorporate a tremendous range of complex bolted connections.

Superbolt can help you solve just about any challenge on your compressor.

Superbolt CN and SP custom tensioners are designed specifically for challenging reciprocating compressor applications. MR and MRA also feature captive jackbolts and are useful on many compressor applications, engines and couplings.

*Foundation Bolts*



*Connecting Rods*



*Main Bearing*



*Crosshead Housing*

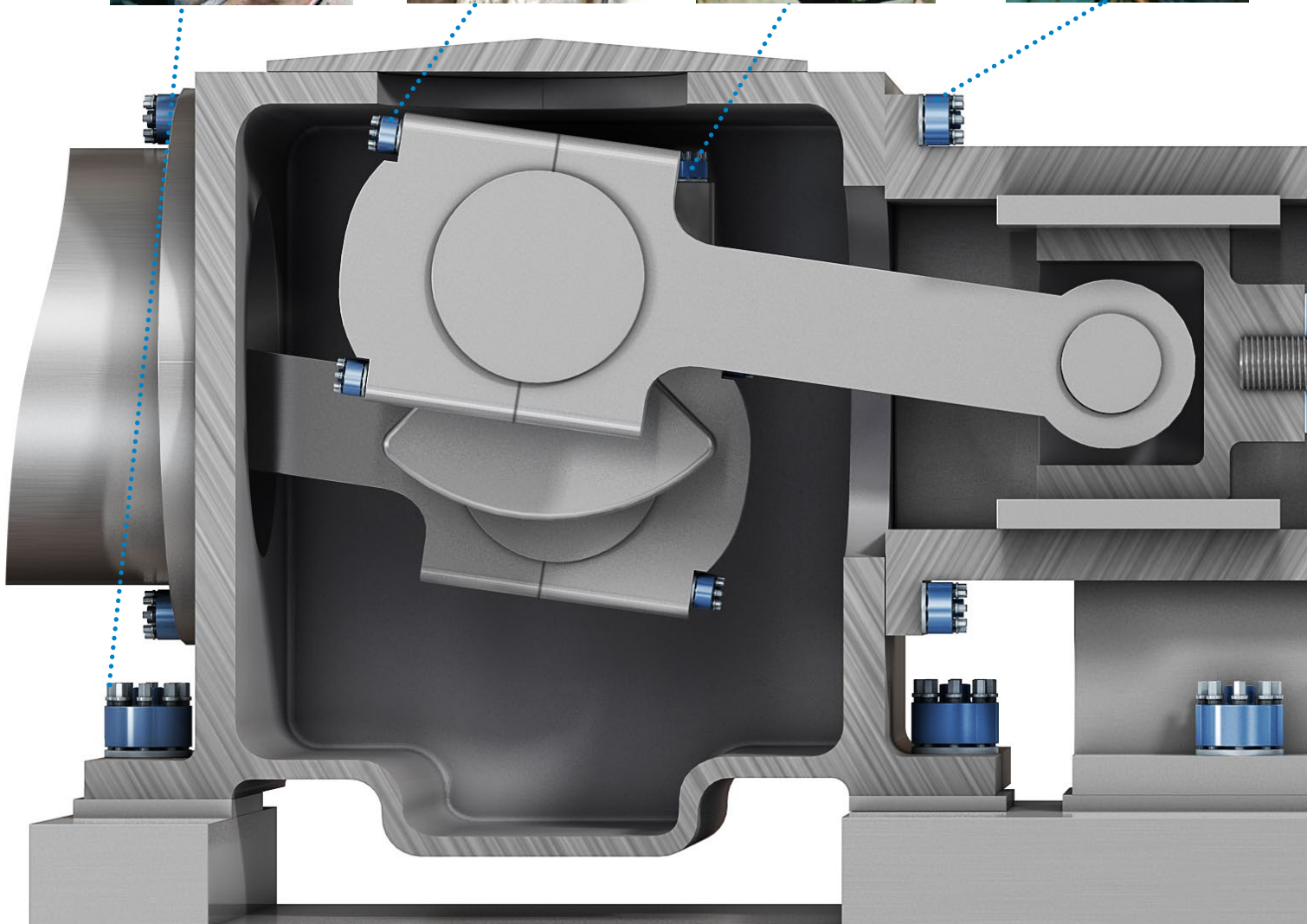

## CN Compressor Crosshead Jamnut

CN compressor crosshead jamnuts are safe and easy to install or remove. Designed in collaboration with a major compressor manufacturer, they incorporate Superbolt captive jackbolts as an added safety feature. An extra-wide bolt circle positions jackbolts away from the piston rod for better wrench clearance.

## SP Compressor Piston End Nut

These custom-designed, nut-style tensioners are ideal for attaching compressor pistons to piston rods. There's no need to clamp the rod when installing or removing Superbolt piston-end nuts, which incorporate captive jackbolts as an added safety feature.

*For sizes and availability of CN and SP tensioners, please contact your local Nord-Lock Group office.*

CN Tensioner on Crosshead



Distance Piece



SP Tensioner on Piston



MT Tensioner on Cylinder Heads

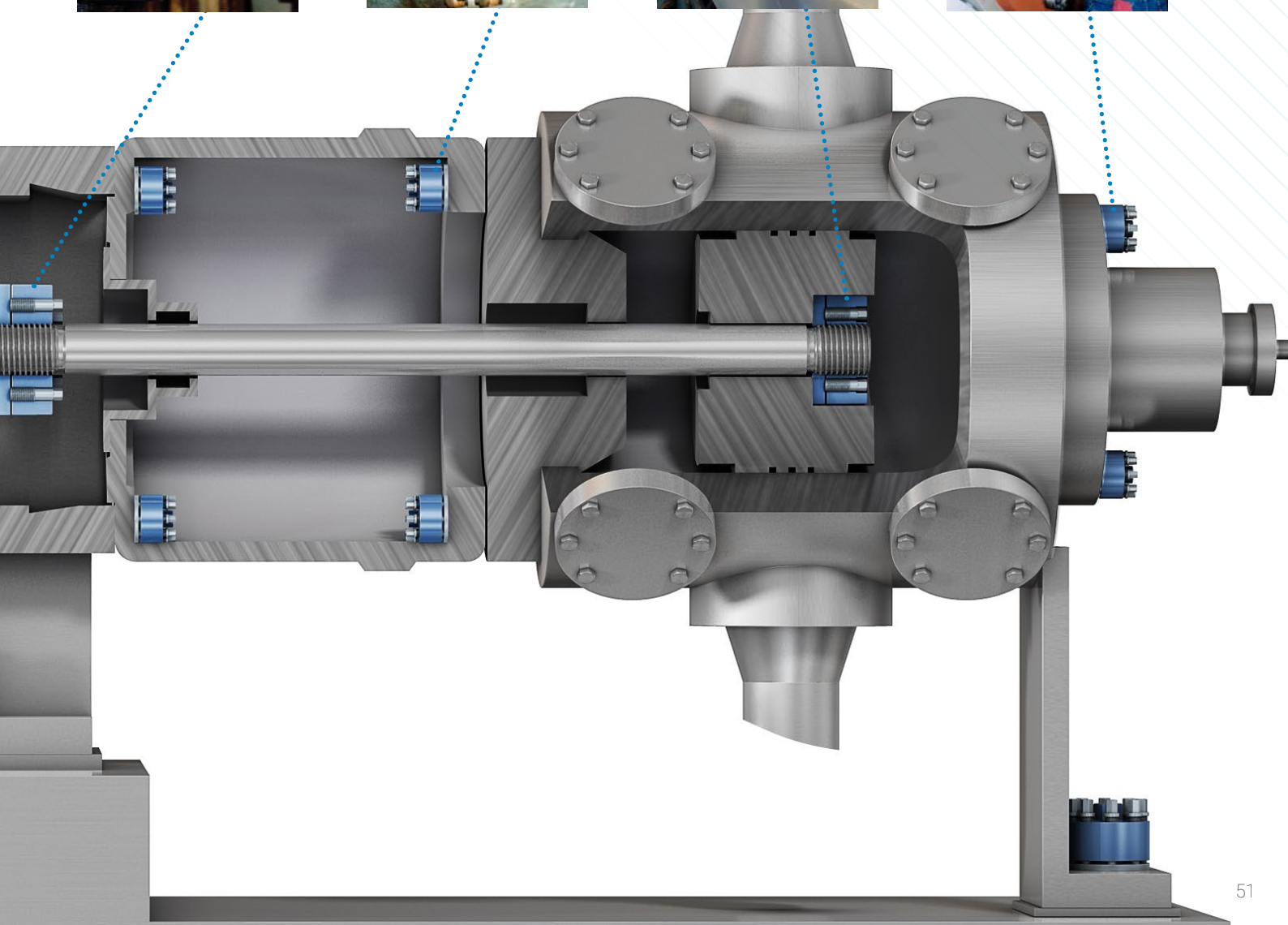



# MR

## Captive jackbolt tensioner

MR Series tensioners meet the special requirements of high-speed rotating machinery. Captively mounted within the tensioner body, these jackbolts can't work free and cause damage when installed.

Components:  
 1 Nut body  
 2 Jackbolts  
 3 Hardened washer

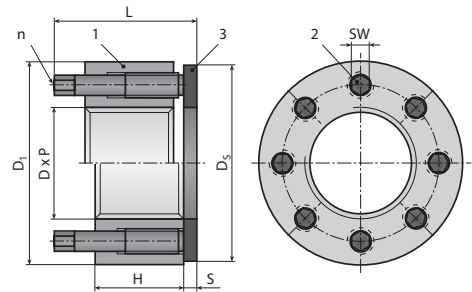

Metric	Size			Nut body		Jackbolt		Hardened washer		Height	Weight	Preload*	Torque*	Preload capacity*	
	Thread	Available pitch			1		2		3						
Part number	D	P <sub>1</sub>	P <sub>2</sub>	P <sub>3</sub>	D <sub>1</sub>	H	n	SW	D <sub>s</sub>	S	tot	est	nom	nom	max
	[mm]	[mm]			[mm]	[mm]		[mm]	[mm]	[mm]	[mm]	[kg]	F	M	[kN]
MR-M16x.../W	M16	2	1.5	1	34	16	4	4	32	3	27	0.10	59	11	75
MR-M20x.../W	M20	2.5	1.5	1	38	16	6	4	38	4	28	0.15	89	11	110
MR-M22x.../W	M22	2.5	1.5	1	41	16	6	4	41	4	28	0.15	89	11	110
MR-M24x.../W	M24	3	2	1.5	44	16	8	4	43	4	28	0.20	120	11	150
MR-M27x.../W	M27	3	2	1.5	50	24	6	6	50	5	42	0.35	155	26	205
MR-M30x.../W	M30	3.5	2	1.5	53	24	6	6	53	5	42	0.35	155	26	205
MR-M33x.../W	M33	3.5	2	1.5	59	24	8	6	59	5	42	0.45	210	26	270
MR-M36x.../W	M36	4	3	1.5	66	32	6	7	66	5	56	0.75	225	46	295
MR-M39x.../W	M39	4	3	1.5	70	32	8	7	70	5	56	0.85	300	46	395
MR-M42x.../W	M42	4.5	3	1.5	75	32	8	7	73	5	56	0.95	300	46	395
MR-M45x.../W	M45	4.5	3	1.5	83	38	8	9	81	6	64	1.45	510	94	675
MR-M48x.../W	M48	5	3	1.5	85	38	8	9	85	6	64	1.45	510	94	675
MR-M52x.../W	M52	5	3	2	94	38	8	9	89	6	64	1.75	510	94	675
MR-M56x.../W	M56	5.5	4	2	100	38	8	9	95	6	64	2.00	510	94	675
MR-M60.../W	M60	5.5	4	2	107	38	10	9	100	6	64	2.25	640	94	845
MR-M64.../W	M64	6	4	2	113	53	8	12	112	8	87	3.50	920	225	1220
MR-M68x.../W	M68	6	4	2	117	53	8	12	117	8	87	3.75	920	225	1220
MR-M72x.../W	M72	6	4	2	120	56	8	12	120	8	87	4.00	920	225	1220
MR-M76x.../W	M76	6	4	2	132	56	12	12	127	8	87	5.00	1370	225	1830
MR-M80x.../W	M80	6	4	2	132	56	12	12	127	8	87	4.70	1370	225	1830
MR-M85x.../W	M85	6	4	2	137	56	12	12	137	8	87	5.00	1370	225	1830
MR-M90x.../W	M90	6	4	2	145	59	16	12	137	8	94	5.85	1830	225	2440
MR-M100x.../W	M100	6	4	2	164	61	16	12	152	8	94	7.60	1830	225	2440
MR-M110x.../W	M110	6	4	2	177	79	12	16	172	10	112	11.10	2290	465	3040
MR-M120x.../W	M120	6	4	2	189	81	16	16	179	10	112	12.75	3050	465	4060
MR-M125x.../W	M125	6	4	2	194	81	16	16	190	10	112	13.00	3050	465	4060

Imperial	Size			Nut body		Jackbolts		Hardened washer		Height	Weight	Preload*	Torque*	Preload capacity*	
	Thread	Available TPI			1		2		3						
Part number	D	P <sub>1</sub>	P <sub>2</sub>	P <sub>3</sub>	D <sub>1</sub>	H	n	SW	D <sub>s</sub>	S	tot	est	nom	nom	max
	[in]				[in]	[in]		[in]	[in]	[in]	[in]	[Lb]	[LBf]	[LBft]	[LBf]
MR-075.../W	3/4	10	16	-	1.47	0.70	4	3/16	1.50	0.13	1.37	0.31	16,300	11	20,400
MR-087.../W	7/8	9	14	-	1.60	0.70	6	3/16	1.63	0.13	1.37	0.34	24,500	11	30,600
MR-100.../W	1	8	12	14	1.90	0.93	6	7/32	2.00	0.19	1.69	0.68	38,900	22	48,600
MR-112.../W	1-1/8	7	8	12	2.08	0.93	6	7/32	2.13	0.19	1.69	0.79	38,900	22	48,600
MR-125.../W	1-1/4	7	8	12	2.25	0.94	8	7/32	2.38	0.19	1.69	0.92	51,900	22	64,800
MR-137.../W	1-3/8	6	8	12	2.46	1.20	6	9/32	2.50	0.19	2.09	1.40	59,000	39	73,800
MR-150.../W	1-1/2	6	8	12	2.70	1.20	8	9/32	2.75	0.19	2.09	1.70	78,800	39	98,400
MR-162.../W	1-5/8	6	8	12	2.96	1.20	8	9/32	2.88	0.19	2.09	2.01	78,800	39	98,400
MR-175.../W	1-3/4	5	8	12	3.08	1.42	8	11/32	3.13	0.25	2.49	2.53	103,700	60	129,600
MR-187.../W	1-7/8	6	8	12	3.59	1.60	8	3/8	3.50	0.25	2.81	4.07	140,200	91	175,200
MR-200.../W	2	4.5	8	12	3.59	1.60	8	3/8	3.50	0.25	2.81	3.87	140,200	91	175,200
MR-225.../W	2-1/4	4.5	8	12	3.95	1.60	8	3/8	3.75	0.25	2.81	4.51	140,200	91	175,200
MR-250.../W	2-1/2	4	8	12	4.45	2.10	8	1/2	4.50	0.31	3.51	7.82	228,500	186	285,600
MR-275.../W	2-3/4	4	8	12	4.70	2.10	8	1/2	4.75	0.31	3.51	8.36	228,500	186	285,600
MR-300.../W	3	4	6	8	5.20	2.10	12	1/2	5.00	0.31	3.51	10.30	342,700	186	428,400
MR-325.../W	3-1/4	4	6	8	5.45	2.20	12	1/2	5.00	0.31	3.51	11.04	342,700	186	428,400
MR-350.../W	3-1/2	4	6	8	5.70	2.30	16	1/2	5.50	0.31	3.87	12.62	457,000	186	571,200
MR-375.../W	3-3/4	4	6	8	6.20	2.40	16	1/2	5.50	0.31	3.87	15.08	457,000	186	571,200
MR-400.../W	4	4	6	8	6.45	2.60	18	1/2	6.00	0.31	4.04	17.31	514,100	186	642,600
MR-425.../W	4-1/4	4	6	8	6.95	3.00	16	9/16	6.40	0.38	4.76	23.41	645,100	312	806,400
MR-450.../W	4-1/2	4	6	8	7.20	3.00	16	9/16	6.65	0.38	4.76	24.44	645,100	312	806,400
MR-475.../W	4-3/4	4	6	8	7.45	3.20	18	9/16	6.90	0.38	4.94	27.13	725,800	312	907,200
MR-500.../W	5	4	6	8	7.70	3.30	20	9/16	7.15	0.38	4.94	28.83	806,400	312	1,008,000

\* All preload and torque values are provided for general reference. Applied preload plus additional bolt load from service should not exceed the maximum bolt or stud capacity. Contact your local Nord-Lock sales office for assistance in determining proper preload and torque settings for your application.  
 - Other sizes, thread pitches or thread per inch (TPI) may be available.  
 - Dimensions listed are representative.

# MRA

## Armored nut-style tensioner

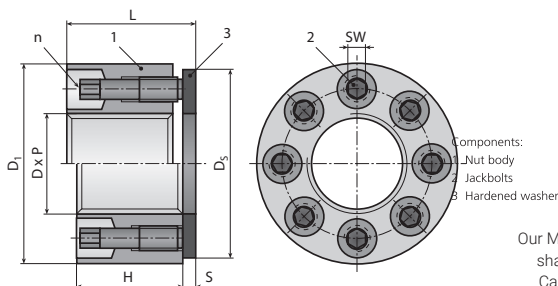

Our MRA series adds mechanical protection to the special requirements of high-speed rotating machinery such as shaft couplings. Jackbolts recessed into the nut body are safe from damage in harsh or abrasive environments. Captively mounted within the tensioner body, these jackbolts can't work free and cause damage when installed.

Metric	Size			Nut body		Jackbolt		Hardened washer		Height	Weight	Preload*	Torque*	Preload capacity*	
	Thread	Available pitch			1		2		3		tot	est	nom	nom	max
Part number	D	P <sub>1</sub>	P <sub>2</sub>	P <sub>3</sub>	D <sub>1</sub>	H	n	SW	D <sub>s</sub>	S	L	[kg]	F	M	[kN]
MRA-M20x.../W	M20	2.5	1.5	1	40	20	8	4	39	5	25	0.17	105	10	135
MRA-M22x.../W	M22	2.5	1.5	1	44	20	8	4	44	5	25	0.21	105	10	135
MRA-M24x.../W	M24	3	2	1.5	48	24	10	4	48	5	29	0.29	135	10	175
MRA-M27x.../W	M27	3	2	1.5	54	27	8	6	53	6	33	0.39	210	26	275
MRA-M30x.../W	M30	3.5	2	1.5	60	27	8	6	60	6	33	0.50	210	26	275
MRA-M33x.../W	M33	3.5	2	1.5	66	33	10	6	63	6	39	0.71	260	26	340
MRA-M36x.../W	M36	4	3	1.5	72	38	8	7	70	8	46	1.04	300	46	400
MRA-M39x.../W	M39	4	3	1.5	78	38	10	7	76	8	46	1.20	375	46	495
MRA-M42x.../W	M42	4.5	3	1.5	84	42	12	7	82	8	50	1.53	450	46	595
MRA-M45x.../W	M45	4.5	3	1.5	90	45	8	9	90	10	55	1.90	510	95	670
MRA-M48x.../W	M48	5	3	1.5	96	48	10	9	95	10	58	2.29	640	95	840
MRA-M52x.../W	M52	5	3	2	104	48	12	9	104	10	58	2.69	810	100	1095
MRA-M56x.../W	M56	5.5	4	2	112	58	12	9	112	10	68	3.75	810	100	1095
MRA-M60x.../W	M60	5.5	4	2	120	64	10	12	120	12	76	4.84	1140	225	1520
MRA-M64x.../W	M64	6	4	2	128	64	10	12	128	12	76	5.55	1140	225	1520
MRA-M68x.../W	M68	6	4	2	136	70	12	12	136	12	82	6.75	1370	225	1825
MRA-M72x.../W	M72	6	4	2	144	70	12	12	144	12	82	7.62	1370	225	1825
MRA-M76x.../W	M76	6	4	2	152	80	14	12	152	12	92	9.52	1600	225	2135
MRA-M80x.../W	M80	6	4	2	160	80	14	12	160	12	92	10.59	1600	225	2135
MRA-M90x.../W	M90	6	4	2	170	86	16	12	170	12	98	12.26	1830	225	2440
MRA-M100x.../W	M100	6	4	2	190	102	12	16	190	16	118	17.86	2310	470	3070
MRA-M110x.../W	M110	6	4	2	209	102	14	16	209	16	118	21.62	2690	470	3575
MRA-M120x.../W	M120	6	4	2	228	102	14	16	228	16	118	26.01	2690	470	3575
MRA-M125x.../W	M125	6	4	2	238	102	16	16	238	16	118	28.37	3070	470	4080

Imperial	Size			Nut body		Jackbolt		Hardened washer		Height	Weight	Pre-load*	Torque*	Preload capacity*	
	Thread	Available TPI			1		2		3		tot	est	nom	nom	max
Part number	D	P <sub>1</sub>	P <sub>2</sub>	P <sub>3</sub>	D <sub>1</sub>	H	n	SW	D <sub>s</sub>	S	L	[Lb]	F	M	[Lbft]
MRA-075-.../W	3/4	10	16	-	1.57	0.79	8	4	1.54	0.20	0.98	0.37	23,600	7	30,400
MRA-087-.../W	7/8	9	14	-	1.73	0.79	8	4	1.73	0.20	0.98	0.46	23,600	7	30,400
MRA-100-.../W	1	8	12	14	1.89	0.94	10	4	1.89	0.20	1.14	0.64	30,400	7	39,300
MRA-112-.../W	1-1/8	7	8	12	2.36	1.06	8	6	2.36	0.24	1.30	1.10	47,200	19	61,800
MRA-125-.../W	1-1/4	7	8	12	2.60	1.30	10	6	2.48	0.24	1.54	1.57	58,500	19	76,400
MRA-137-.../W	1-3/8	6	8	12	2.67	1.30	10	6	2.56	0.24	1.54	1.60	58,500	19	76,400
MRA-150-.../W	1-1/2	6	8	12	3.07	1.50	10	7	2.99	0.31	1.81	2.65	84,300	34	111,300
MRA-162-.../W	1-5/8	6	8	12	3.31	1.65	12	7	3.23	0.31	1.97	3.37	101,200	34	133,800
MRA-175-.../W	1-3/4	5	8	12	3.54	1.77	8	9	3.54	0.39	2.17	4.19	114,700	70	150,700
MRA-187-.../W	1-7/8	6	8	12	3.78	1.89	10	9	3.74	0.39	2.28	5.05	143,900	70	188,800
MRA-200-.../W	2	4.5	8	12	4.09	1.89	12	9	4.09	0.39	2.28	5.93	182,100	74	246,200
MRA-225-.../W	2-1/4	4.5	8	12	4.41	2.28	12	9	4.41	0.39	2.68	8.27	182,100	74	246,200
MRA-250-.../W	2-1/2	4	8	12	5.04	2.52	10	12	5.04	0.47	2.99	12.24	256,300	166	341,700
MRA-275-.../W	2-3/4	4	8	12	5.67	2.76	12	12	5.67	0.47	3.23	16.80	308,000	166	410,300
MRA-300-.../W	3	4	6	8	5.98	3.15	14	12	5.98	0.47	3.62	20.99	359,700	166	480,000
MRA-325-.../W	3-1/4	4	6	8	6.40	3.15	14	12	6.40	0.47	3.62	23.79	359,700	166	480,000
MRA-350-.../W	3-1/2	4	6	8	6.69	3.39	16	12	6.69	0.47	3.86	27.03	411,400	166	548,600
MRA-375-.../W	3-3/4	4	6	8	6.89	3.39	16	12	6.89	0.47	3.86	27.82	411,400	166	548,600
MRA-400-.../W	4	4	6	8	7.48	4.02	12	16	7.48	0.63	4.65	39.37	519,300	347	690,200
MRA-425-.../W	4-1/4	4	6	8	8.23	4.02	14	16	8.23	0.63	4.65	47.66	604,800	347	803,700
MRA-450-.../W	4-1/2	4	6	8	8.40	4.02	14	16	8.40	0.63	4.65	48.26	604,800	347	803,700
MRA-475-.../W	4-3/4	4	6	8	8.98	4.02	14	16	8.98	0.63	4.65	57.34	604,800	347	803,700
MRA-500-.../W	5	4	6	8	9.37	4.02	16	16	9.37	0.63	4.65	62.55	690,200	347	917,300

\* All preload and torque values are provided for general reference. Applied preload plus additional bolt load from service should not exceed the maximum bolt or stud capacity. Contact your local Nord-Lock sales office for assistance in determining proper preload and torque settings for your application.

- Other sizes, thread pitches or thread per inch (TPI) may be available.

- Dimensions listed are representative.





120



## Real-life testing and validation at your site

Our skilled engineers can perform a thorough investigation of your bolted connections, including real-life tests or validation, at your site.



## SECTION INCLUDES

- Extreme requirements for any challenge
- Extreme industry applications
- Unique designs for your requirements

# CUTTING-EDGE SOLUTIONS

**Bolted connections are difficult to set up, maintain, and disassemble under normal conditions. Add challenges such as heat and pressure, and your job just got a whole lot tougher.**

As an example, forging presses must handle extraordinary forces routinely. But when you need to prestress or disconnect large-diameter columns and tie rods, you experience first-hand the giant gap between human-sized effort and the super-human torque that the job requires. Similarly, when your installation gets as hot as a reactor's pressure vessel, you know ordinary nuts and bolts won't give you the long-term security that safety and proper functioning require. Under extreme conditions, experienced plant engineers turn to Superbolt for high-preload, large-size, or heat-resistant tensioners that translate mechanical advantage into maintenance reductions, cost savings, and faster, safer operations.





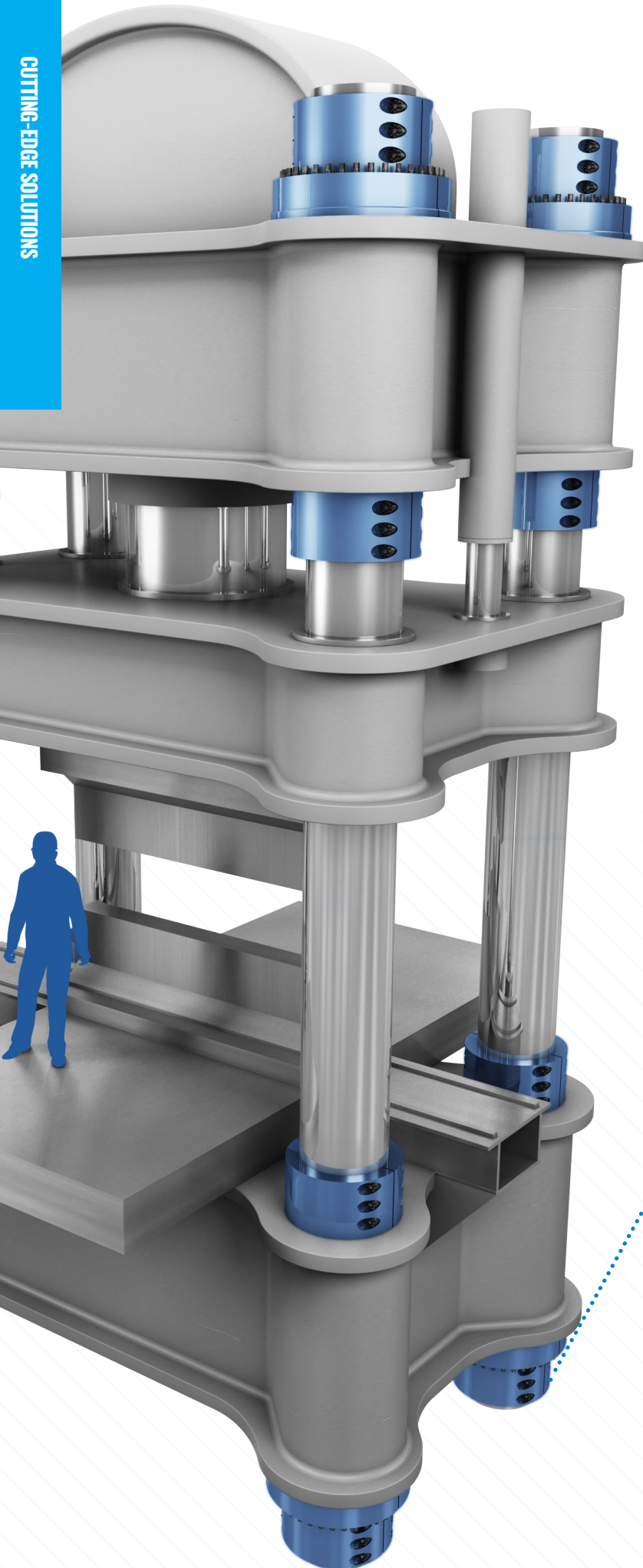

# EXTREME REQUIREMENTS FOR ANY CHALLENGE

## Large diameters & high preload

Other bolting methods would be heavily challenged to solve the many bolting problems found in giant machines such as forging presses, cranes, or mining machines. All of these have large diameter nuts and bolts well over M100 (4 inch) that require extremely high preloads. Superbolt is right at home in these applications and still allows you to achieve the preload, getting the job done without increased hassle. Thread diameters of 1,5 M (60 inch) and with clamp ranges up to 90 MN (20 Mlbf) have been produced.



## Superbolt STC

Innovative and easy to use Split-Nut Thrust Collar (STC) tensioners are the perfect solution for large sized threads and high preload requirement applications. A threaded split nut (1) is positioned over a threadless ring (2). When tightened, the jackbolts – which are contained in the ring – push against a hardened washer (3) and cause the ring to thrust against the split nut, thereby preloading the joint. The installation is quicker and with less heavy turning equipment.

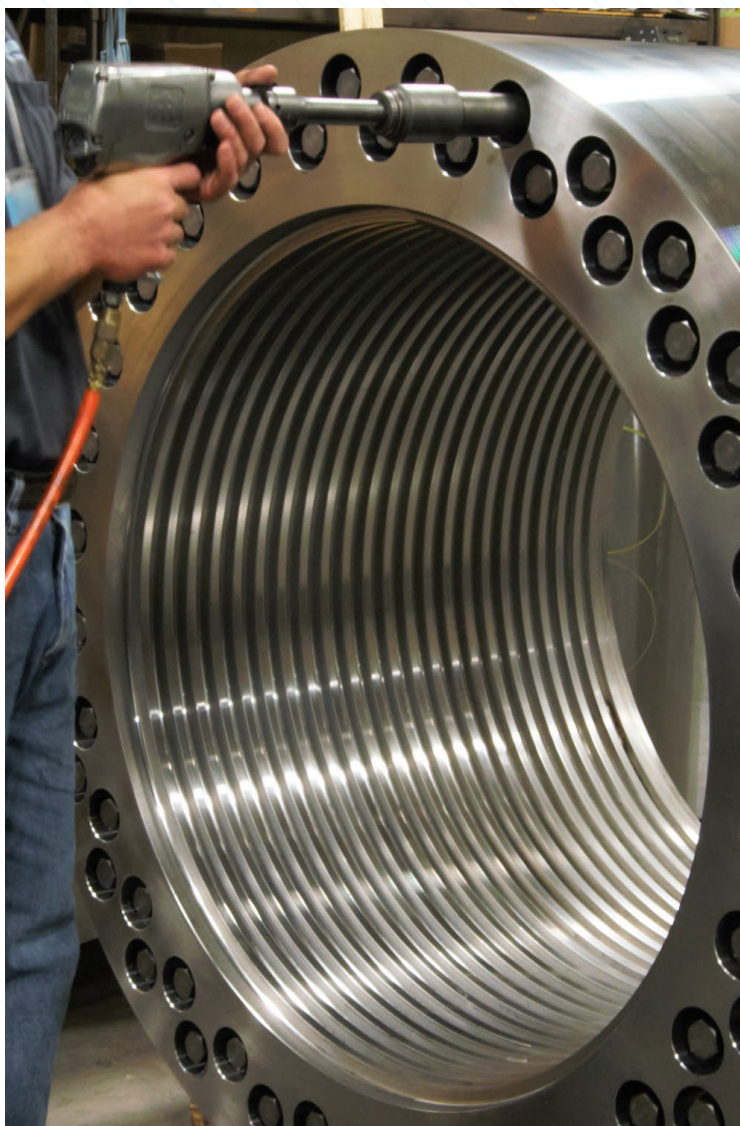

Assembling an enormous 1016 mm (40 inch) thread tensioner, used on a 50,000 ton press.

## Material Requirements, Environmental & Corrosion Protection

No matter the environment, Superbolt has plenty of product-enhancing options to keep things protected. From stainless steels to various coatings, we can meet your requirements in humid environments, offshore & salt water splash zones or chemical exposure. In addition to corrosion protection, coatings can be beneficial for various purposes, e.g., color-coding, durability and conductivity enhancement, as well as friction control.

### Stainless materials adapted for the requirements:

- Martensitic
- Austenitic
- Duplex
- Precipitation hardened
- Inconels & Monels

### Examples of coatings and platings including:

- Electroless nickel
- Xylan
- Zinc
- Black oxide
- Zinc flake
- PVC & metal caps



The world's largest bolt-style Superbolt being installed in a two-post hydraulic forging press.

## High- & low-temperature tensioners



Extreme temperatures increase the complexity of bolting. Superbolt products are available in solutions to meet temperature ranges of  $-270^{\circ}\text{C}$  ( $-450^{\circ}\text{F}$ ) to  $600^{\circ}\text{C}$  ( $1150^{\circ}\text{F}$ ). Due to the complexities of low- and high-temperature bolting, Superbolt offers a variety of solutions based on the temperatures and code requirements. Such cases are often found in power or petrochemical plants where extremely low temperatures (liquid hydrogen, fusion reactors, etc.) and extremely high temperatures (combustion chambers, turbines, steel mills, furnace equipment) exist.





# IT'S JUST ROCKET SCIENCE.

## EXTREME INDUSTRY APPLICATIONS



### Space

Superbolt is rocket science! Not that it is difficult to handle or use, but we have the bolting know-how that space environments require. We are useful on launch craft equipment, satellites, International Space Station (ISS), and many more. Since there are no torsion effects and only small handheld tooling is needed, the small torques on the jackbolts make bolting possible in non-gravity environments. Additionally, space-approved lubricants are utilized.

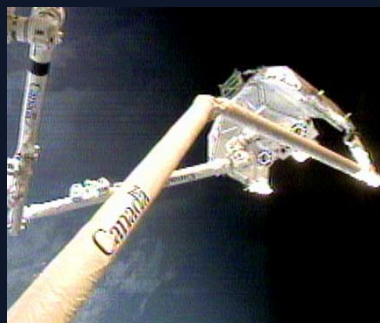

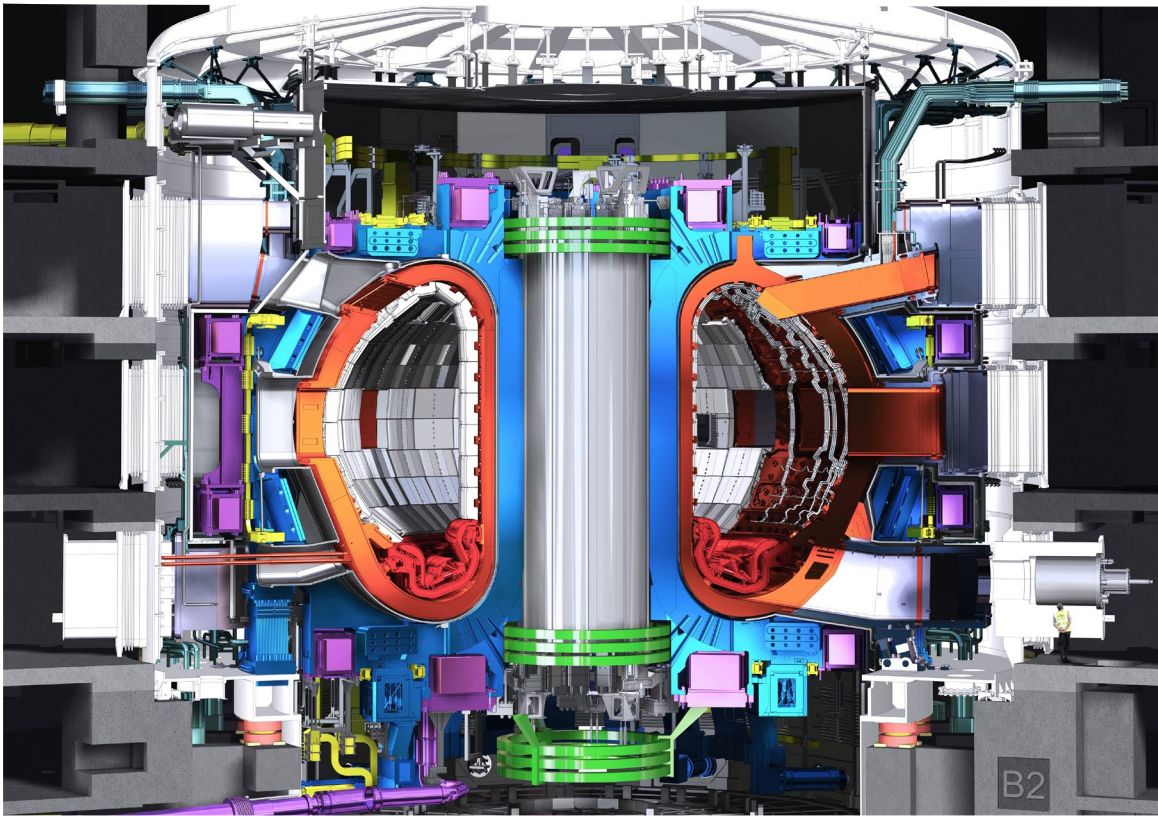

Credit: ITER Organization, <http://www.iter.org/>

## Fusion Power

Superbolts are ideal for Tokamak structures where there is a mixture of bolting complexity and extreme requirements. This means the need for precise material properties, meeting extreme bolt loads, working within limited spaces, and where both extremely high and low temperatures exist is now possible. Superbolt is ideally suited for applications like ITER.



## Nuclear Power Generation

Superbolt tensioners are ideal for nuclear plant critical and high-radiation applications. Significant savings in worker exposure and outage time are realized. Applications examples: valves, heaters, manways, pumps, turbines, shaftline couplings. Manufactured from approved materials.

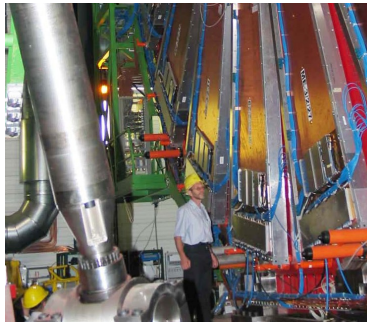

## Particle Accelerators

Superbolt provided over 1,400 nut-and-bolt-style tensioners and pins for securing the assembly of 30-foot diameter magnet endcap disks inside the underground tunnel that holds the collider. Large loads were required and only small spaces were available.



## Defense Land, air or sea

Superbolt tensioners are ideally suited for the many "can't fail" extreme applications required for national defense. Superbolt offers Resistant Hull Integrity Stud/Bolt Tensioners designed as an alternative to heavy hex monel self-locking nuts. They are shock-qualified and salt-waterproof, ideally suited for commercial marine, navy, and offshore applications.



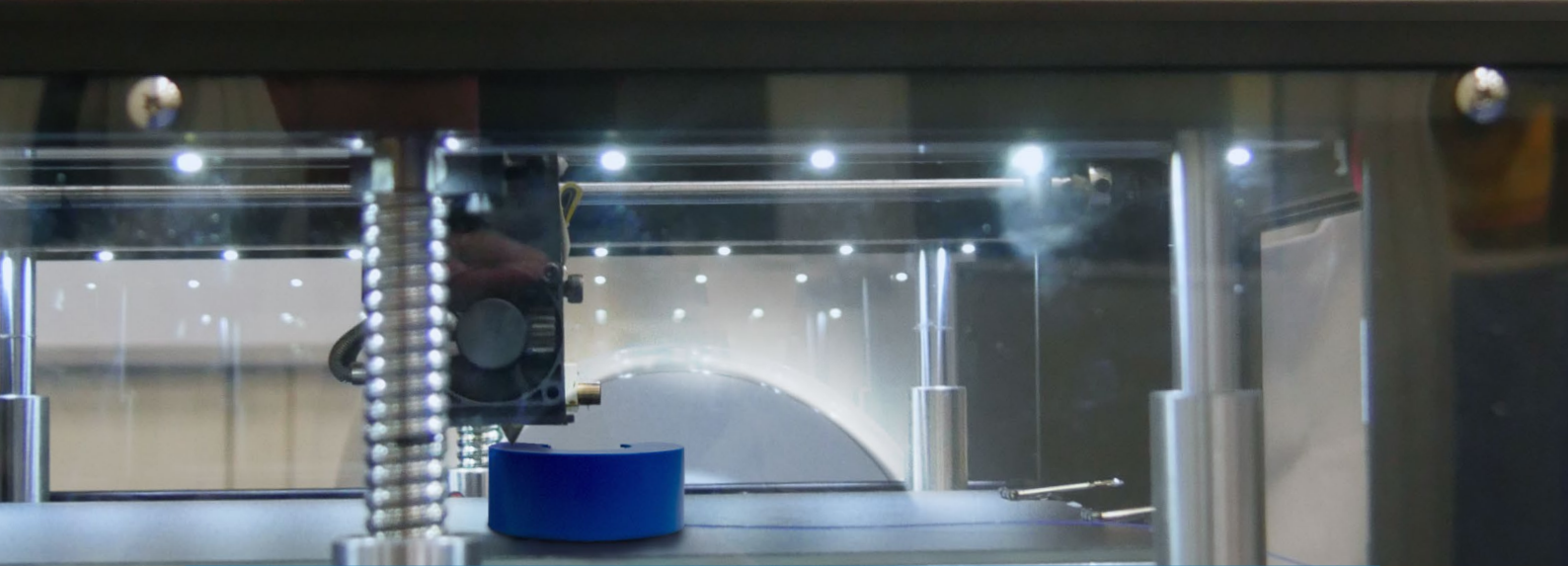

---

## UNIQUE DESIGNS FOR YOUR REQUIREMENTS

---

Ever since the beginning, we have been proud of our ability to meet any bolting challenge. From engineering to design to manufacturing to installation, from our standard range, our pre-engineered range or customized solutions, we have the know-how to provide the right design for your application. The following are just a few examples of what we can do.



## Offshore/Sub-sea

Superbolt offers a unique combination of features built into this specialized multi-jackbolt tensioner for offshore bolting applications. It incorporates three key features:

- 1) The washer is captive to the nut body to prevent loss of the washer,
- 2) corrosion protection to address the harsh conditions, and
- 3) integral flats on the nut for turning assistance on difficult stud threads.

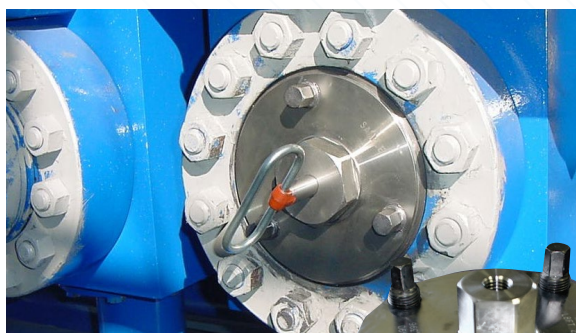

## Externally Threaded Tensioners (ETT)

An ETT is an externally threaded tensioner that provides a pushing force for loading or sealing a mating piece (compression member). Unlike conventional nut-style tensioners with an internal threaded portion and machined-surface outer diameter, an ETT has its threads machined onto the outer diameter. The ETT can be solid or hollow (i.e. bored center hole but unthreaded). The ETTs use multi-jackbolt technology to generate compression loads for assembly components in machinery. They simply are turned into position. A large hex or some other provided turning tool is used to facilitate nut turn-down. The jackbolts, which are tightened to a prescribed torque with low-energy handheld tools, push directly against the loading piece. Strong compression or sealing forces are generated.

## Customized studs

We sell a majority of tensioners, but also offer one-source shopping for your entire joint hardware. We offer customized studs to meet and deliver a complete bolted package. We have comprehensive threading know-how and an extensive inventory of gaging equipment. Why not choose a Superbolt nut-style tensioner, stud and flexnut kit? Sizes from M16 to over M300 are possible and in a wide variety of materials. We have rolled thread capability and can handle many thread configurations and standards (ISO, DIN, ANSI, Whitworth, Acme, Trapezoidal, and Buttress).

## Tamper-proof tensioners



Superbolt offers a tamper-resistant jackbolt design. The tamper-resistant jackbolts are a product improvement for Superbolt's multi-jackbolt tensioner (MJT) bolting system and are intended for use in security-sensitive applications. Tamper-resistant jackbolts are designed to protect MJTs from unwanted tightening and loosening. They utilize an abnormally shaped head set in a counter-bore hole, which requires a special tool attachment to torque or un-torque the jackbolts.





# YOUR PARTNER IN BOLTING SOLUTIONS



Joining parts together is one of the most critical steps when delivering a product or system. The Nord-Lock Group is focused on making the world a safer place by offering secure bolting solutions for any challenge.

#### **Innovative technologies**

The technologies in our portfolio are developed in-house and are available in a wide range of materials and sizes. Our solutions are specified by world-leading companies within all major industries. Our products hold extensive certifications and are known for their reliability and high quality.

#### **Unmatched expertise**

Maximizing customer uptime in today's market means offering competitive solutions over the whole operational life-cycle. The Nord-Lock Group offers knowledge partnership including on-site and remote support, combined with the technical verification carried out from our in-house laboratories. All this to ensure safe and efficient bolting.

#### **Global partnership**

We fully control the manufacturing process of our technologies and offer global availability. We have distribution centers in strategic locations and work with a network of authorized partners all over the world.

Find out more about Nord-Lock Group  
[www.nord-lock.com](http://www.nord-lock.com)

## COMPLETE RANGE OF TENSIONING SOLUTIONS

In addition to Superbolt solutions, world-renowned hydraulic bolting provider Boltight is part of the Nord-Lock Group. Our extensive experience and wide range of solutions allows us to recommend or design the optimum solution for any bolting challenge.

### BOLTIGHT HYDRAULIC TENSIONING

Boltight solutions have been at the forefront of the hydraulic tensioning business for many years. The tools feature advanced technology and are designed for critical applications within various industries. By working in partnership with customers, new ways to deliver cost-effective solutions for numerous industrial bolting applications have been developed.

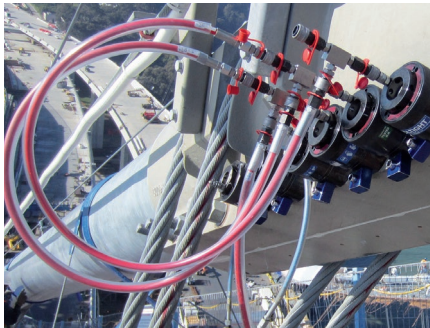

- Strong and robust designs ensure durability and long operating life
- Lightweight designs ensure that tools are easy to work with
- Precise engineering offers smooth, trouble-free operation
- Clever solutions such as spring return tensioners to save time
- Equipment conforms to European Pressure Equipment Directive and is CE marked

### OTHER NORD-LOCK GROUP TECHNOLOGIES

#### Nord-Lock Original wedge-locking solutions when failure is not an option

Nord-Lock wedge-locking solutions are recognized around the world for their ability to secure bolted joints exposed to severe vibration and dynamic loads. An ideal solution for bolted joints where failure is not an option.



#### Expander System advanced and cost-effective solution for lug wear

Expander System is a permanent solution for lug wear, which is a common reason for equipment breakdowns. The technology eliminates the need for welding and line boring while allowing broader tolerances.







# WHEN SAFETY REALLY MATTERS

Safer, easier to work with, and far more reliable than conventional bolting methods, Superbolt multi-jackbolt tensioners have proven their superiority in thousands of successful installations. The key is a patented design that divides the load among multiple small jackbolts, giving you an overwhelming mechanical advantage. Connections stay tight indefinitely, yet a single worker can torque or un-torque the most massive assemblies with ordinary hand tools.

*The Nord-Lock Group is focused on solving the toughest bolting challenges. We offer a unique combination of bolting expertise and a wide product range – all designed and developed in-house.*



**NORD-LOCK**  
GROUP